

August, 1974 | | 75 cents

# Electronic Servicing



A HOWARD W. SAMS PUBLICATION

## **INTERLACED SCANNING... Fact Or Myth?**

**Advice For TV Beginners  
67 Years Of "Know-How"  
Reports From Test Lab**

# PTS ELECTRONICS

## Precision Tuner Service



now available near you

ALABAMA: 524 32ND ST. SOUTH BIRMINGHAM, ALA. 35222 TEL. 205. 323-2657	CALIFORNIA—NORTH: 4611 AUBURN BLVD. SACRAMENTO, CALIF. 95841 TEL. 916. 462-6220	CALIFORNIA—SOUTH: 5111 UNIVERSITY AVE. SAN DIEGO, CALIF. 92105 TEL. 714. 280-7070	COLORADO: 4958 ALLISON ST. ARVADA, COLO. 80001 TEL. 303. 473-7080	FLORIDA: 1918 BLANDING BLVD. JACKSONVILLE, FLA. 32210 TEL. 904. 389-9952	FLORIDA—SOUTH: 12934 N.W. 7TH AVE. MIAMI, FLA. 33168 TEL. 305. 685-9811	HOME OFFICE—INDIANA: 5233 S. HWY. 37 BLOOMINGTON, INDIANA 47401 TEL. 812. 824-9331	KANSAS: 3116 MERRIAM LANE KANSAS CITY, KANSAS 66100 TEL. 913. 831-1222
TEXAS—EAST: 4324-26 TELEPHONE RD. HOUSTON, TEX. 77032 TEL. 713. 644-6793	<p>..new pts products.. ..pts 115 dura-seven..stop..seven piece alignment tool kit..stop..glass- filled polymer plastic for longer life.. ..stop..up to 10 times the life of regular plastic tools..stop ..\$2.49.. ..see your distributor or any pts service center..stop.. ..pts elcx..not a franchise Co..</p>					LOUISIANA: 2914 WYTCWOOD DRIVE METAIRIE, LOUISIANA 70033 TEL. 504. 885-2349	
TEXAS—MOUTH: MOPAC LANE LONGVIEW, TEX. 75001 TEL. 214. 753-4334						MARYLAND: 1105 SPRING ST. SILVER SPRING, MD. 20910 TEL. 301. 565-0025	
PENNSYLVANIA—EAST: 1921 S. 70TH ST. PHILADELPHIA, PA. 19142 TEL. 215. 724-0999						MASSACHUSETTS: 191 CHESTNUT ST. SPRINGFIELD, MASS. 01103 TEL. 413. 734-2737	
PENNSYLVANIA—WEST: 257 RIVERVIEW AVE. W. PITTSBURGH, PA. 15202 TEL. 412. 761-7648						MICHIGAN: 13709 W. 3 MILE RD. DETROIT, MICH. 48235 TEL. 313. 862-1783	
PENNSYLVANIA—EAST: 1921 S. 70TH ST. PHILADELPHIA, PA. 19142 TEL. 215. 724-0999						MINNESOTA: 815 W. LAKE ST. MINNEAPOLIS, MINN. 55408 TEL. 612. 824-2333	
OREGON: 5220 N.E. SANDY BLVD. PORTLAND, OREGON 97213 TEL. 503. 282-9636	OKLAHOMA: 3007 N. MAY OKLAHOMA CITY, OKLA. 73106 TEL. 405. 947-2013	OHIO—SOUTH: US TUNER SERVICE 8180 VINE ST. CINCINNATI, OHIO 45215 TEL. 513. 821-2298	OHIO: 5887 STATE RD. CLEVELAND, OHIO 44134 TEL. 216. 845-4480	NORTH CAROLINA: 724 SIEGLE AVE. CHARLOTTE, N.C. 28205 TEL. 704. 332-8007	NEW YORK CITY— NEW JERSEY: 156 MARKET ST. E. PATERSON, N.J. 07407 TEL. 201. 791-6380	NEW YORK: 993 SYCAMORE ST. BUFFALO, N.Y. 14212 TEL. 716. 891-4935	MISSOURI: 8458 PAGE BLVD. ST. LOUIS, MO. 63130

## LET US TAKE CARE OF YOUR TUNER PROBLEMS...

PTS will repair any tuner - no matter how old or new - black & white or color - transistor or tubes - varactor or electronically tuned - detent UHF. 8 hour service is a must!

### ...THIS IS THE SERVICE WE OFFER:

1. Fastest Service—8 hour—in and out the same day. Overnight transit to one of our strategically located plants.
2. Best Quality—Your customers are satisfied and you are not bothered with returning tuners for rework.
3. PTS uses only ORIGINAL PARTS! No homemade or make-do, inferior merchandise (this is why we charge for major parts!). You get your tuner back in ORIGINAL EQUIPMENT condition.
4. PTS is recommended by more TV Manufacturers than any other tuner company.
5. PTS is overhauling more tuners than all other tuner services combined.



Fast **8** hr. Service!

We offer you finer, faster...

...Precision  
Tuner Service

## 1 YEAR GUARANTEE

VHF, UHF \$10.95  
UV-COMBO 17.95  
IF-SUBCHASSIS 12.50  
Major parts and shipping  
charged at cost.  
(Dealer net!)

Over 4000 exact tuner replace-  
ments available for \$14.95 up  
(new or rebuilt).

ELECTRONICS, INC....

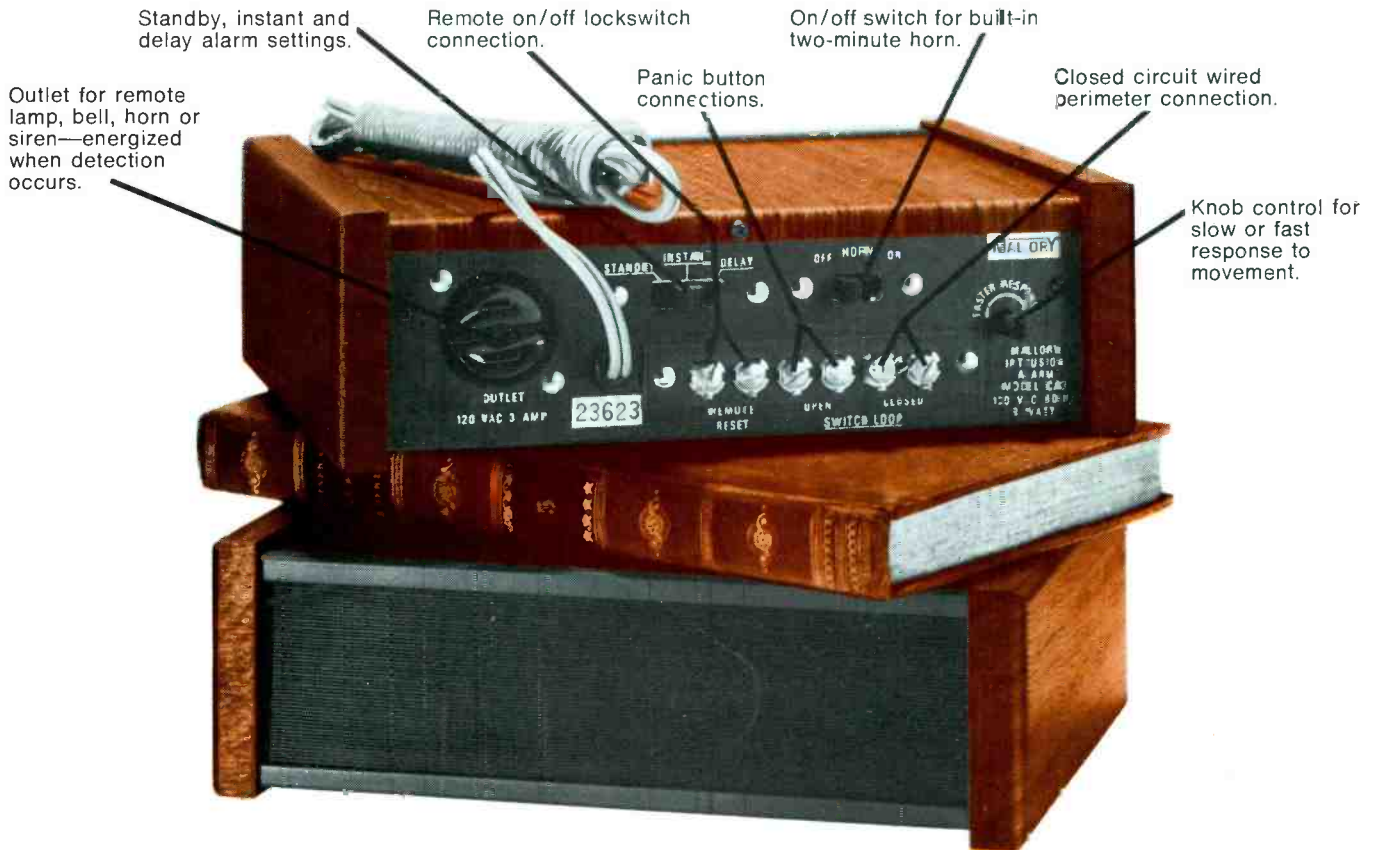
...Number ONE and still trying harder!  
(Not a Franchise Company)

For More Details Circle (1) on Reply Card



# The new Mallory CA3 Intrusion Alarm.

## Reliable.



## (And inconspicuous.)

This area-and-perimeter device creates and transmits an ultrasonic wavelength field for detection up to a distance of 20 feet. And because of its modern design and walnut-grain finish, the CA3 is attractive and inconspicuous enough to pass as a radio or stereo tuner.

Virtually any movement by an intruder (or a break in the perimeter circuit) activates the built-in horn and the remote outlet for two minutes. An automatic

reset handles the possibility of a new or renewed intrusion. And special CA3 circuitry guards against false alarms from line transients and insects. A variety of companion indoor or outdoor accessory devices is available.

The Mallory CA3 Ultrasonic Intrusion Alarm. From the manufacturer of the most complete line of do-it-yourself security products. Another sound reason to see your Mallory distributor today.

### MALLORY

#### MALLORY DISTRIBUTOR PRODUCTS COMPANY

a division of P. R. MALLORY & CO. INC.  
Box 1284, Indianapolis, Indiana 46206; Telephone: 317-261-1501

Batteries • Capacitors • Controls • Security Products • DURATAPE® • Resistors • Semiconductors • SONALERT® • Switches • Timing Devices and Motors

DURACELL® DURATAPE® and SONALERT® are registered trademarks of P. R. Mallory & Co. Inc.

For More Details Circle (4) on Reply Card

# electronic scanner

news of the industry

---

**Philco-Ford Corporation announced that it will discontinue** manufacturing radios and stereo-component systems once current production is completed. The company will continue to make stereo consoles, reports **Radio and Television Weekly**.

**RCA Electronic Components** showed a complete 13V, 15V, 17V, and 19V line of the 90-degree matrix precision in-line tube system, and 110-degree delta tri-color-dot tubes in 19V and 25V sizes at the 1974 IEEE Spring Conference. The in-line system permits permanent attachment of the deflection yoke to the tube, simplifying installation and eliminating costly and time-consuming tube alignment.

**The Admiral Group of Rockwell International has introduced** a line of 29 portable and table color television models in five screen sizes ranging from 12 to 19 inches. All of the 13 console models have 25-inch picture tubes and ten are completely solid state. Nine of the portable units also are 100% solid state, as reported in **Home Furnishings Daily**.

**Quasar Electronics Corporation has introduced** a new generation of 100% solid-state color TV chassis, the QS3000, which features a "Super InstaMatic" color-tuning system. According to an article in **Merchandising Week**, the proprietary color-demodulator integrated circuit is controlled by a CdS light sensor so the picture is adjusted automatically according to changes in the intensity of room lighting.

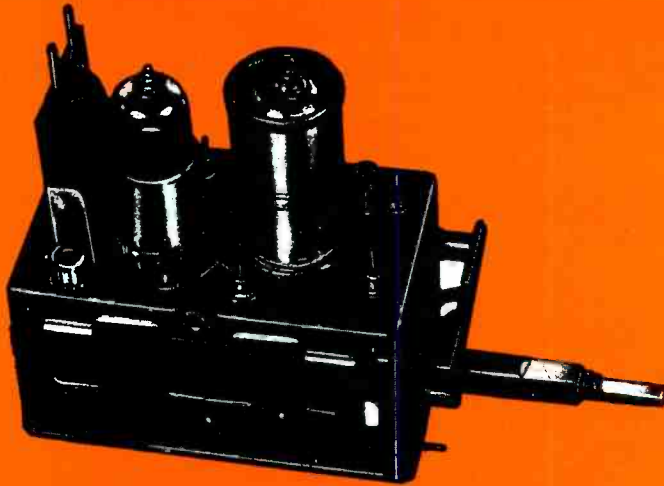
**The consumer electronics division of RCA Corporation said it will phase out** of the home audio products business by next year and concentrate only on television-related home equipment. **Wall Street Journal** reported that the RCA 1975 line will include radios, stereo phonographs, and tape recorders but it will be the last line. RCA Records will continue to operate as a separate division.

**Codevintec Pacific, Incorporated** will set up a showroom at its Woodland Hills, California, plant on July 1 to display the first consumer electronics products to be imported from the USSR. Initial products will include Yundst and Silelis black-and-white televisions and Selena multi-band portable radios. Color TV and electronic instrumentation will be imported at a later date, according to **Home Furnishings Daily**.

**The Advent Corp.** of Cambridge, Massachusetts, is marketing a color projection television set with a 4 X 6 foot screen. It is priced at \$2495, and 120 units have been sold, reports **Radio and Television Weekly**.

(Continued on page 6)





# \$9.95

ALL PARTS INCLUDED

EXCEPT TUBES & TRANSISTORS

ONE YEAR GUARANTEE

## TUNER SERVICE CORPORATION

PROVIDES YOU WITH A COMPLETE SERVICE FOR ALL YOUR TELEVISION TUNER REQUIREMENTS.

### REPAIR

VHF Or UHF Any Type \$9.95.  
UHF/VHF Combo \$15.00.

In this price all parts are included, tubes, transistors, diodes, and nuvistors are charged extra. This price does not cover mutilated tuners.

Fast efficient service at our conveniently located service centers.

All tuners ultrasonically cleaned, repaired, realigned and air tested.

### REPLACE

Universal Replacement Tuner **\$12.95** (In Canada \$15.95)

This price buys you a complete new tuner built specifically by **SARKES TARZIAN INC.** for this purpose.

All shafts have a maximum length of 10½" which can be cut to 1½".

Specify heater type parallel and series 450mA or 600mA.

### CUSTOMIZE

Customized tuners are available at a cost of only **\$15.95**; (with trade-in **\$13.95**) (In Canada \$17.95/\$15.95)

Send in your original tuner for comparison purposes.



WATCH US GROW

HEADQUARTERS	BLOOMINGTON, INDIANA 47401	537 S. Walnut Street	Tel. 812-334-0411
ARIZONA	TUCSON, ARIZONA 85713	1528 So. 6th Street, P.O. Box 4534	Tel. 602-791-9243
CALIFORNIA	NORTH HOLLYWOOD, CALIF. 91601	10654 Magnolia Boulevard	Tel. 213-769-2720
	BURLINGAME, CALIF. 94010	1324 Marsten Road	Tel. 415-347-5728
	MODESTO, CALIF. 95351	123 Phoenix Avenue	Tel. 209-521-8051
FLORIDA	TAMPA, FLORIDA 33606	1505 Cypress Street	Tel. 813-253-0324
GEORGIA	ATLANTA, GEORGIA 30310	938 Gordon Street S.W.	Tel. 404-758-2232
ILLINOIS	CHAMPAIGNE, ILLINOIS 61820	405 East University Street	Tel. 317-356-6400
	CHICAGO, ILLINOIS 60621	737 West 55th Street	Tel. 312-873-5556-7
	SKOKIE, ILLINOIS 60076	5410 West Brown Street	Tel. 312-675-0230
INDIANA	HAMMOND, INDIANA 46323	6833 Grand Avenue	Tel. 219-845-2676
	INDIANAPOLIS, INDIANA 46204	817 North Pennsylvania St.	Tel. 219-845-2676
KENTUCKY	LOUISVILLE, KENTUCKY 40208	2920 Taylor Boulevard	Tel. 502-634-3334
LOUISIANA	SHREVEPORT, LOUISIANA 71104	3025 Highland Ave.	Tel. 318-861-7745
MARYLAND	BALTIMORE, MD. 21215	5505 Reisterstown Rd., P.O. Box 2624	Tel. 301-358-1186
MISSOURI	ST. LOUIS, MISSOURI 63132	10530 Page Avenue	Tel. 314-429-0633
NEVADA	LAS VEGAS, NEVADA 89102	1412 Western Ave. No. 1	Tel. 702-384-4235
NEW JERSEY	JERSEY CITY, NEW JERSEY 07307	547-49 Tonnelle Avenue HWY. I & 9	Tel. 201-792-3730
	TRENTON, NEW JERSEY 08638	901 N. Olden Ave.	Tel. 609-393-0999
OHIO	CINCINNATI, OHIO 45216	7450 Vine Street	Tel. 513-821-5080
	CLEVELAND, OHIO 44109	4597 Pearl Road	Tel. 216-741-2314
OREGON	PORTLAND, OREGON 97210	1732 N.W. 25th Avenue	Tel. 503-222-9059
TENNESSEE	GREENEVILLE, TENNESSEE 37743	1215 Snapps Ferry Road	Tel. 615-639-8451
	MEMPHIS, TENNESSEE 38111	3158 Barron Ave.	Tel. 901-458-2355
TEXAS	DALLAS, TEXAS 75218	11540 Garland Road	Tel. 214-327-8413
VIRGINIA	NORFOLK, VIRGINIA 23513	4295 Santos Street	Tel. 703-855-2518
CANADA	ST. LAURENT, MONTREAL, QUEBEC H4N-2L7	305 Decarie Blvd.	Tel. 514-748-8803

FOR INFORMATION ON FRANCHISE, CONTACT HEADQUARTERS

For More Details Circle (5) on Reply Card

**Roland F. Nobis, president of PTS Electronics, Incorporated, has announced the opening** of three new tuner-repair centers. They are at 12934 NW 7th Avenue, Miami, Florida, 13709 West 8 Mile Road, Detroit, Michigan, and 3614 Lamar Avenue, Memphis, Tennessee. PTS now has 26 wholly-owned service centers.

**Philco-Ford's 1975 line features 26 new color models**, of which 21 use improved versions of the company's BOSS chassis. Two models of the redesigned chassis are offered: BOSS and a high-performance BOSS 300, both incorporating 13 plug-in modules and up to eight IC's, and equipped with voltage protection and regulating devices, as reported in **Merchandising Week**.

**Three young inventors** in New York, Thomas Shannon, Walter DeMaria, and Maris Ambata, **claim they have developed a video-projection system** that can be retailed for less than \$1000. The projector requires circuit changes in the television set and as a result is not compatible with all TV sets. **Home Furnishings Daily** reports that the device was demonstrated to engineers from Japanese and U.S. television manufacturers.

**RCA Corporation has introduced its 1975 line** of all-solid-state color-TV receivers with optional retail price increases of \$10 to \$40. Although there are fewer models than before, all new models feature AFT and negative-matrix picture tubes, reports **Home Furnishings Daily**.

**An M.I.T. report** based on a two-year study of consumer durable products **found that color TV servicing costs** account for 35% of the total dollars spent on color TV, while the price of electrical power represented 53% and the initial purchase price 12%. According to **Home Furnishings Daily**, the report stated that a color TV owner will spend about \$400 during the "useful life" of the product, an estimated 10 years.

**Quasar Electronics Corporation**, the former consumer-products division of Motorola which was recently purchased by Matsushita of Japan, has named Akira (Arthur) Harada as vice chairman. Keiichi (Tex) Takeoka, Quasar chairman and chief executive, said he will serve as acting president until one is elected later this year, reports the **Wall Street Journal**. Matsushita expects to invest \$40 million in modernization of the Quasar color-TV manufacturing facilities. Later, Panasonic color sets might be built in Quasar plants. As reported in **Home Furnishings Daily**, Quasar will increase color-TV prices 2.8% to 6.5%, and b-w prices more than 7%.

**The EIA/Consumer Electronics Group** in cooperation with the Chicago Board of Education officially **opened its fourth electronic opportunity training school** at the Industrial Skill Center in southwest Chicago on June 11. Designed to provide minority groups with instruction in the servicing of consumer electronics, students receive more than 800 hours of detailed instruction over a period of approximately 48 weeks. □



# Our New Digital IC color generator deserves a hand...

MODEL  
1230  
ACTUAL SIZE



## YOURS!

The time you waste running back to the truck to pick up your bulky color convergence generator costs you money. B & K's solution to the problem is the model 1230 Digital IC Color Generator—a solution you can hold on the palm of your hand.

How much performance can you expect from a package just 1 $\frac{3}{4}$ " high, 5" wide and 7 $\frac{3}{4}$ " deep that snuggles nicely into the place of a few tubes in your caddy? Plenty—like a broadcast-stable 10,000 $\mu$ V signal with four rock-steady patterns so jitter-free that you can expand and examine the quality of the color subcarrier with an oscilloscope. And that's unique.

Why is it so stable? Because all video, sync, blanking and color signals are derived from a crystal-controlled 4.751748MHz master oscillator. Because of the progressive scan system, which presents the same signal on each field. Because all counting functions and signal processing are performed by accurate, reliable digital integrated circuits. And because the ripple-free regulated power supply maintains generator stability even under abnormal line conditions. No expensive batteries to replace, either.

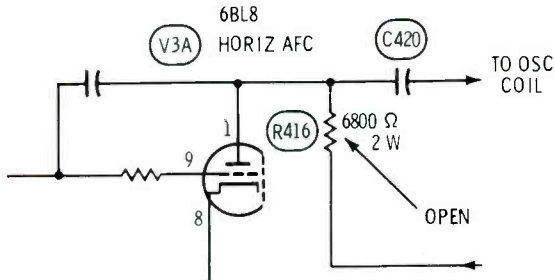
Plenty of good reasons to get your hands on one today. In stock at your distributor or write DYNASCAN.

MODEL 1230 \$96.00

**B&K** PRODUCTS OF  
**DYNASCAN**  
1801 W. Belle Plaine Ave.  
Chicago, IL 60613 • (312) 327-7270

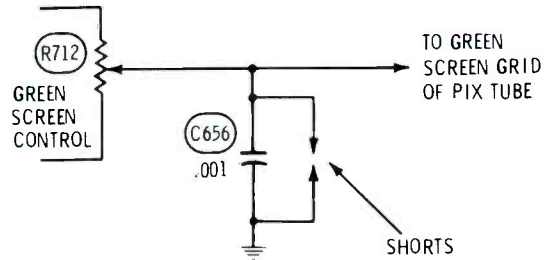
For More Details Circle (6) on Reply Card

Chassis—GTE Sylvania D16  
PHOTOFACT—1325-2



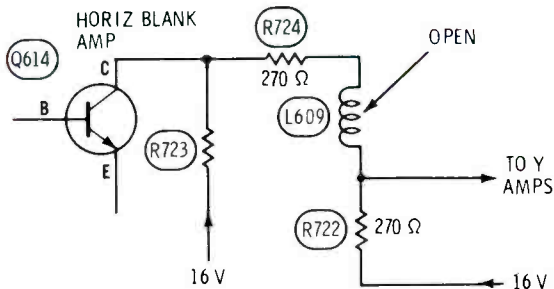
**Symptom**—Horiz hold control has no effect  
**Cure**—Check R416, and replace if it is open

Chassis—GTE Sylvania D16  
PHOTOFACT—1325-2



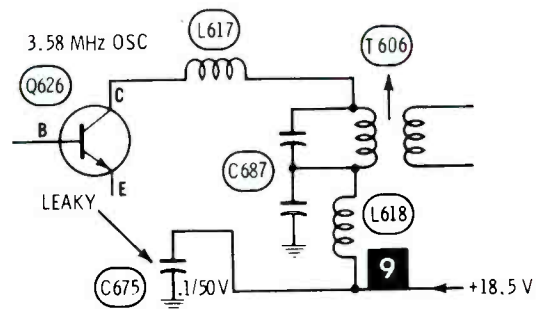
**Symptom**—Intermittent loss of green from raster  
**Cure**—Check or replace C656 spark gap

Chassis—GTE Sylvania D19  
PHOTOFACT—1269-3



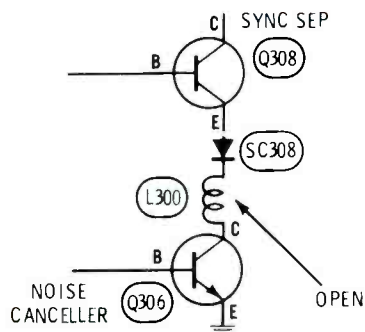
**Symptom**—Low brightness, and poor color  
**Cure**—Check L609, and replace if it is open

Chassis—GTE Sylvania D16  
PHOTOFACT—1325-2



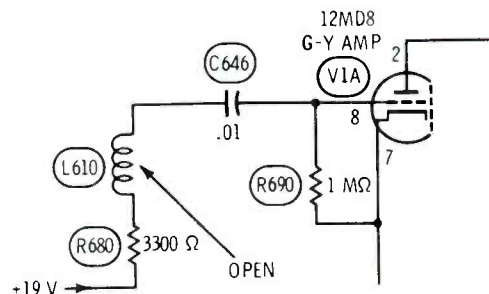
**Symptom**—No color, weak sensitivity  
**Cure**—Check C675, and replace if it is leaky and reducing supply voltage

Chassis—GTE Sylvania D16  
PHOTOFACT—1325-2



**Symptom**—No vertical or horiz sync  
**Cure**—Check L300, and replace if it is open

Chassis—GTE Sylvania D18  
PHOTOFACT—1322-3



**Symptom**—Left edge of screen is green  
**Cure**—Check L610, and replace if it is open



# reader's exchange

Need a not-available schematic? Need an obsolete part? Have an unusual service problem and want help? Send information and full mailing address to ELECTRONIC SERVICING. Other ES readers should send replies with their offer of help direct to the writer. We reserve the right to edit and print all letters sent to this column. **Let us help one another.**

**Needed:** Schematic for a Jackson model 650-A capacitor tester. It is an old one and does not work on the high scale.

Bill Clarke  
Clarke Radio Service  
623 Main Street  
Caldwell, Ohio 43724

**Needed:** Schematic for a Tektronix type 315D oscilloscope.

David Paananen  
2515 Dupont North  
Minneapolis, Minnesota 55411

**Needed:** Schematic and operating instructions for Jackson model TVG-1 TV-FM sweep generator and Superior model TV-50A genometer.

Lou Jorji  
1009 Montclair Road  
Cocoa, Florida 32922

**Needed:** Schematic and operating instructions for a Paco model S-50 push-pull oscilloscope. Also have for sale these old tubes: UX-201A, 78, 24A, 27, 41, 45, UX226, CX301A, 01A, 42, 80, 47, 97X, and 36.

Edward E. Smith  
5425 South 52nd Street  
Omaha, Nebraska 68117

**Needed:** Schematic for a Cornell Dubilier model BF-50 capacitor analyzer.

N. Tiffin  
Independence Audio Productions  
212 South Willow  
Independence, Missouri 64053

**Needed:** Schematic for an Elektra Amplidyne Research Company model SE-III stereo loudspeaker equalizer. Especially need the specifications of the 14-pin IC.

Joel Huneke  
3671 Hudson Manor Terrace  
Riverdale, New York 10463

**Needed:** Schematic and other service data for RCA model C-11-1 radio.

Laird A. Scott  
Route 1, Box 71-A  
Jefferson, Wisconsin 53549

**Needed:** Service literature for an Estey model 1307 organ.

J. M. Sullivan  
Lee's Electronics  
1313 George Washington Way  
Richland, Washington 99352



## WINEGARD AMPLIFIED PRODUCTS PROVEN IN OVER 1,000,000 INSTALLATIONS.

### CASE IN POINT: WINEGARD PREAMPLIFIERS.



For quality and dependability in antenna preamplifiers, look to Winegard. You know they're good. Because our preamplifiers deliver the best reception and the best reliability in the industry today.

Winegard preamplifiers come in 12 different broad-band models and a complete range of single channel models. With Winegard preamplifiers you get all these features:

- work with any TV antenna
- 75 or 300 ohm output
- solid-state, printed circuit cartridge
- unique lightning protection circuit
- switch selectable FM trap
- pre-amp and downlead connections 100% protected from weather and industrial deposits
- power supply included in all models

Best TV products for Best TV reception

**WINEGARD**  
TELEVISION SYSTEMS

Winegard Company • 3000 Kirkwood Street • Burlington, Iowa 52601

For More Details Circle (7) on Reply Card

## BLUE SHOWER DEGREASER

MUCH MORE THAN JUST A TUNER CLEANER . . .

BLUE SHOWER is the complete degreaser for all circuitry . . .

Cleans dusty flybacks • • dirty chassis • • and contaminated tuners

And it comes with our new OMNI-SPRA® extension

that cleans backs and sides of components as well as the front

Comes in two sizes . . . one for the bench and one more for the road



© OMNI-SPRA is a Reg. T.M. of TECH SPRAY, Inc.

YOU CAN HELP US CONSERVE STEEL

BLUE SHOWER cans are refillable when empty. Take them to any participating distributor — he will credit you 5 cents for each can and return them to TECH SPRAY for refilling.



From **TECH SPRAY** where we find solutions for your problems  
Amarillo, Texas 79105

# troubleshootingtips

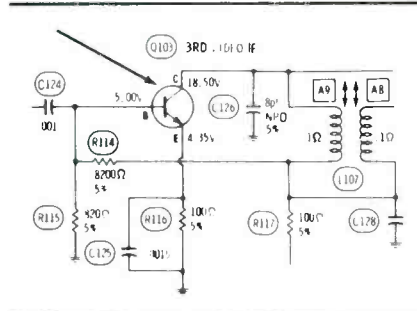
Send in your helpful tips—we pay!

## Intermittent picture Zenith 25CC50 color chassis (Photofact 1267-3)

When the receiver was first turned on, the screen showed only a blank white raster. Ten minutes later the picture and sound appeared. Everything was normal for about twenty minutes, then the video and sound became intermittent.

I tried to inject a signal at the input of the IF's, but it would not go through. This cleared the tuner of suspicion. All the AGC voltages seemed to be okay. A heat lamp placed over the IF section would bring the picture back within a minute or so.

Next, I made DC voltage checks in the IF circuit and found those in the 3rd IF to be wrong when the picture disappeared. The base of Q103 was about 5 volts with picture and 1.7 without. And the emitter was approximately 4.3 volts with picture or 1.2 without. All the symptoms pointed toward a defect in the 3rd IF stage.

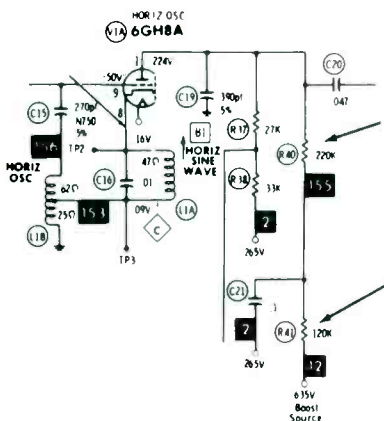


As a crosscheck, I heated the whole IF box, then sprayed individual components with coolant. When I got to the 3rd IF transistor, a short whiff of coolant immediately would bring back the picture. I replaced the transistor, and cured the intermittent.

I didn't suspect transistors because I have heard it reported many times that they normally aren't intermittent; that when they go, they remain out. This experience proves transistors can be intermittent.

J. B. Adkins  
Albany, Georgia

## Intermittent horizontal and locking RCA CTC51 color chassis (Photofact 1332-2)



Originally, the symptoms were a slight instability of the horizontal locking. I aligned the horizontal circuit and thought it repaired. After a few more days, it was

having horizontal jitters after warm up.

I changed the horizontal tubes and the phase detector diodes and checked the voltages. Still the jitters were there. After more hours of operation, the width became intermittent and there was critical horizontal locking.

High voltage and B-boost both were low. After many voltage and resistance checks, I found R40 and R41, which supply part of the oscillator plate voltage, were decreased in value. After replacing these resistors, I found the symptoms were relieved. Evidently the resistors were arcing or noisy internally.

Lloyd Lemons  
Englewood, Colorado

## Intermittent color and locking Sylvania D14 (Photofact 1168-3)

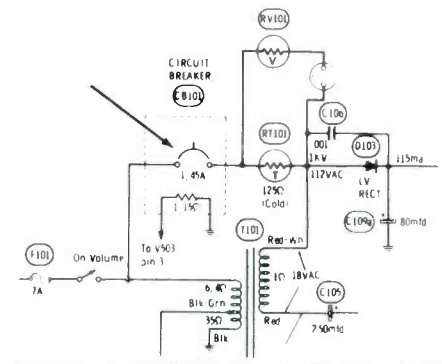
Symptoms of weak or intermittent color saturation accompanied by poor color locking indicated a loss of gain before the burst keyer. And normal b-w reception proved the video stages were not at fault.

The best procedure is to use color bars, and then trace the signal from the video through the chroma bandpass amplifier by using a scope.

We have found several cases where L600 was open, or intermittently open.

Stan Simms  
Nutley, New Jersey

## Tripping circuit breaker Ward's Airline Model GC112420E (Photofact 1147-2)



Because the passing of time has almost healed the scar tissue of my traumatic experience, I will try to share with you a very unusual repair job.

It began quite innocently with a circuit breaker that would not stay reset. I replaced the breaker, checked the tubes, replacing those found defective, and confidently sat back to enjoy my reward. Instead, an out-of-focus tiny raster was glaring at me.

Hurriedly, I ran through a checklist of measurements. Grid output of the 24LQ6 horizontal output tube was about -100 volts DC instead of -60 the schematic showed, boost and high voltage were low, and the cathode current was only about 125 mills. Although a growing panic mercifully numbed my senses, I vaguely remembered finding an open circuit between the cap of the 24LQ6 and the cap of the 3A3 HV rectifier.



A new flyback was obtained and installed. Unfortunately, the high voltage now fluctuated between 18KV and 27KV. I measured resistance of the new flyback and found the HV winding measured about 350 ohms, whereas the schematic called for 750 ohms.

A second flyback was installed. Now the raster was an unstable mass that vaguely resembled an hourglass with nearly full width at the top, narrow in the center, and wide at the bottom of the screen.

Another ohmmeter test of the flyback showed another open. This time the 24LQ6 plate cap had a firm grip on the insulation, but no continuity. Words are inadequate to describe my feelings as I repaired that plate cap.

This time when the power was applied, nothing came out but a tiny puff of smoke, from whence I knew not. As unlikely as it seems, the circuit breaker was open, and could not be reset.

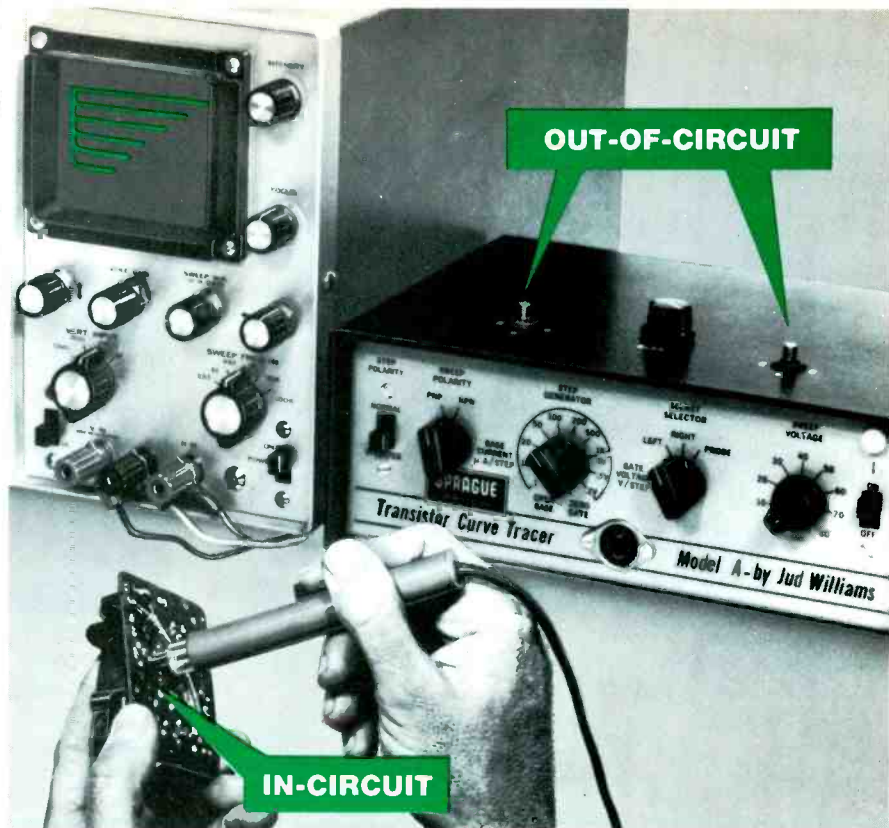
With the mixed feelings of dogged determination and complete hopelessness, I installed another circuit breaker. And could not believe my senses to hear a familiar rustle and see a normal, bright raster.

An autopsy performed on the first replacement circuit breaker showed the 1.15-ohm winding (wired in the cathode circuit of the 24LQ6) was only a clinker, and the sidewall of the case was blackened.

In the future, I hope to remember to check the voltage of the output tube cathode, even if I believe it to be grounded!

C. E. Leukering  
Metropolis, Illinois

**Editor's Note:** Similar problems with other models have shown the origin to be leakage inside the circuit breaker between the 120 VAC wiring and the winding of the breaker wired in the cathode circuit of the horizontal-output tube. Moderate leakage hum-modulates the picture width and the high voltage. When the leakage becomes severe, the breaker is burned open. A fast test is to disconnect the cathode wire and ground the cathode terminal of the socket direct to chassis. Normal width is proof AC is getting into the cathode wiring.



## The fastest, easiest, most-reliable, least-expensive way to test transistors

### Sprague's Model A Transistor Curve Tracer by Jud Williams Incorporates Dynamic Signature Pattern™ Servicing Technique

#### Eliminate transistor damage.

Did you ever unsolder a transistor to test it, find it defective, then wonder if it was ruined in removal? Or, if the device tested OK, how about the ticklish job of resoldering without damage to either transistor or board? The solution to such problems is in-circuit testing with the "Signature Pattern" technique.

#### What are Signature Patterns?

They are scope readouts of the dynamic impedance of in-circuit transistors. With this unique test method, the transistor under test is actually **turned on**, not merely made to oscillate, as with conventional techniques. The "Signature Pattern" method of trouble-shooting has these definite advantages: (1) Quick, decisive, "good-or-bad" tests of suspect transistors; (2) Discovery of defective components within transistor circuits even when transistors are good; (3) Elimination of damage to transistors and other components; (4) Safe testing with system power removed.

#### Quick, accurate tests.

By observing the family of curves, you can determine at a glance such parameters as gain, linearity, saturation, avalanche point, and leak-

age. No zeroing or balancing is necessary. The Model A also performs the all-important breakdown voltage test. It will identify a transistor type as either silicon or germanium. In addition, it will analyze an FET as either junction-type or insulated gate, as well as determine the pinch-off voltage.

#### Service modules profitably.

With more and more set-makers switching to modular circuitry, it becomes economically difficult for service shops to stock a variety of plug-in panels in quantity . . . not to mention excessive costs to your customers when panel replacements are made. Also, you waste valuable time processing paper work and preparing modules for shipment to the factory for repair or credit. The practical solution is to quickly and economically repair defective modules in your own shop with the "Signature Pattern" test technique.

#### Low-cost testing.

When the Sprague Model A Curve Tracer is connected to any general-purpose scope, you have the most complete semiconductor testing facility possible at a budget price . . . only \$149.50.

Get the Sprague Model A Transistor Curve Tracer from your Sprague distributor now. Or, ask him for Brochure M-957. If his supply of brochures is depleted, write to Sprague Products Co., 105 Marshall St., North Adams, Mass. 01247.



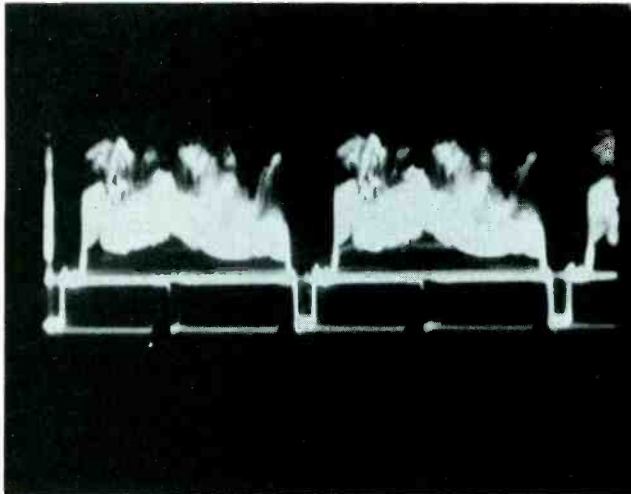


Fig. 1 When video is viewed at horizontal rate, what causes those lines between the blanking pedestals and sync pulses? (Answer in Fig. 11.)

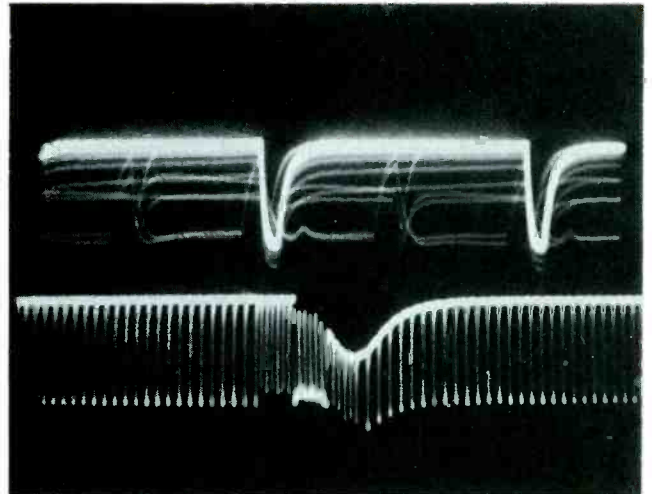


Fig. 2 Top trace shows many extra lines in the sync separator output (horizontal rate). A change to vertical rate and widening the trace proves the extra lines are vertical equalizing, sync, and sweep pulses; all parts of the waveform occurring only during the vertical blanking interval.

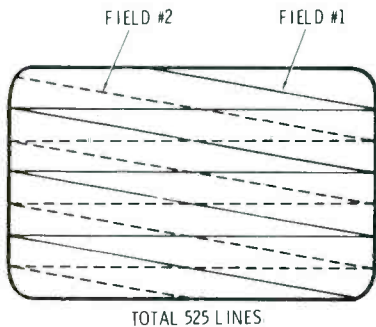


Fig. 3 This is the textbook concept of interlaced scanning of the two vertical fields.

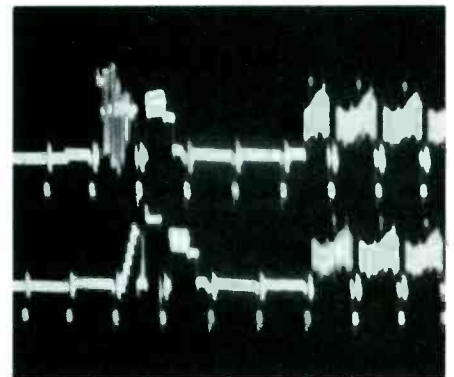


Fig. 4 At top of the screen is what appears to be a half scanning line. However, scope waveforms (picture at right) show it is produced by blanking, not scanning.

# INTERLACED SCANNING...FACT OR MYTH?

By Carl Babcoke, CET

*During research on the Vertical-Interval Test Signals (VITS), my attention was drawn to something about the vertical-retrace period that didn't seem to make sense. According to theory, we should be able to see about 480 scanning lines in a TV picture. **There's only half that many!** Are the text books wrong about interlaced scanning of the twin vertical fields?*

The subject of interlaced scanning was far from my thoughts as I began to photograph the Vertical-Interval Test Signals (VITS) from a TV video detector. However, some discrepancies between the scope waveforms and what was seen on the screen of the TV led me to make tests I hadn't planned. Results of those tests seemed to indicate that the two vertical scanning fields did **not** interlace (lines of one alternating with the lines of the

other field); instead the corresponding horizontal-scanning lines of **both** fields traced the same common line.

Details of the scope adjustments for each waveform will be given, so you can crosscheck them for yourself. However, I must warn you that it's almost impossible to obtain some of them without using a triggered-sweep scope, preferably one having dual-trace capabilities. The waveforms were photographed



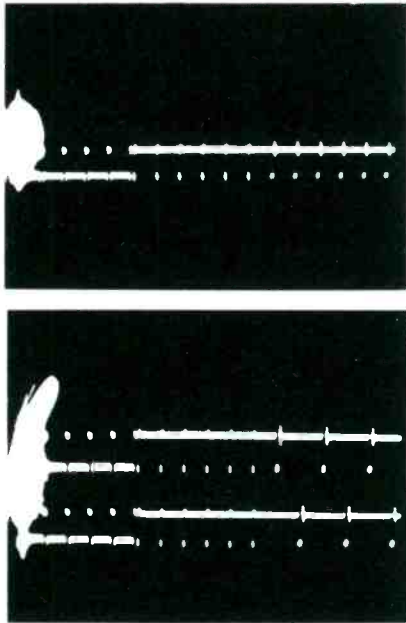


Fig. 5 Single-trace waveform of the vertical sync and post-equalizing pulses wrongly shows the same spacing between all the pulses (top picture). Dual-trace waveforms (bottom picture) show the correct half spacing of vertical sync and equalizing pulses, and the full spacing between normal horizontal sync pulses on the right.

from a B&K Model 1470, a Hewlett-Packard Model 1220A, and a Telequipment Model D61, all dual-trace scopes.

### Extra Lines In The Video

Waveforms on the new triggered-sweep scopes were steady, bright, and sharp. They were just the kind of fine displays that scope-lovers have dreamed about, and often despaired of obtaining.

The doubts began to form. What was causing the horizontal lines (Figure 1) connecting the shoulders of the blanking pulses? Also unexplained were the faint lines similar to narrow sync pulses located about midway between the horizontal sync pulses. These are the kind of lines we often paint out of our waveform pictures before they are printed, because they obscure some of the desired details.

When using older scopes, I blamed some of these extra lines on loose scope locking. Question: Is there something about video wave-

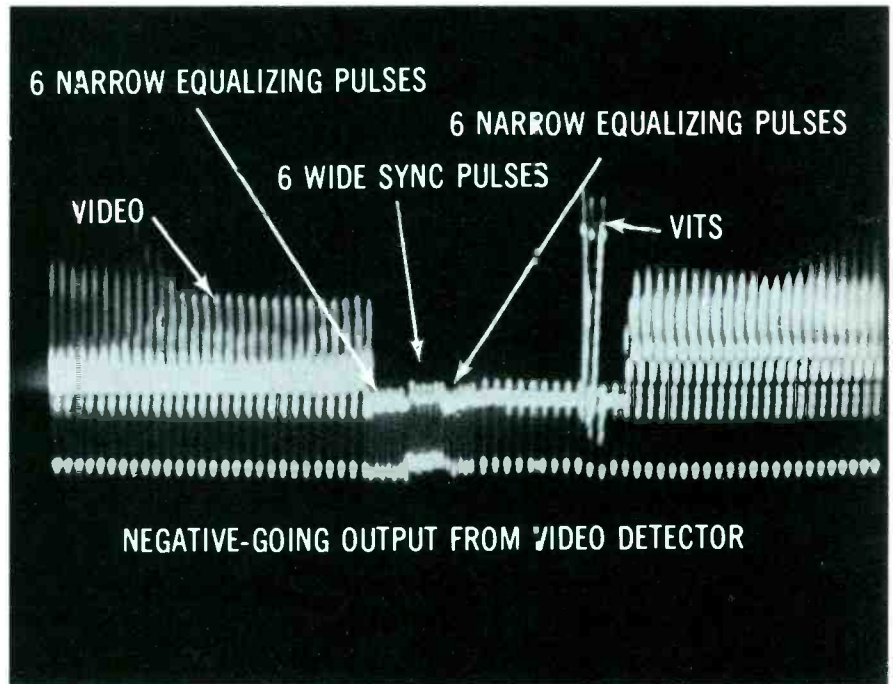


Fig. 6 Only a triggered-sweep scope can show you this kind of picture of vertical field #2.

forms preventing solid scope locking? Only a minute was required to change the scope for external sync, with horizontal-sweep pulses from the receiver used for locking. **There was no difference;** the locking was rock-solid both ways, but the extra lines were not affected.

Incidentally, here's a tip for anyone whose scope does not have an internal sync separator to help lock video waveforms. Bring in a sample of sweep voltage (vertical or horizontal as needed) from the receiver under test, connect it to the "ext sync" terminal of the scope, and adjust the controls for good locking. Horizontal pulses often can be picked up by merely attaching the wire clip around the **insulation** of a yoke or sweep wire. Vertical pulses can be obtained from the convergence voltages.

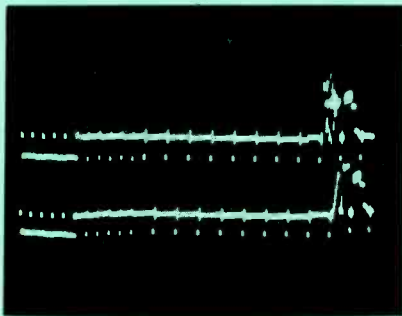
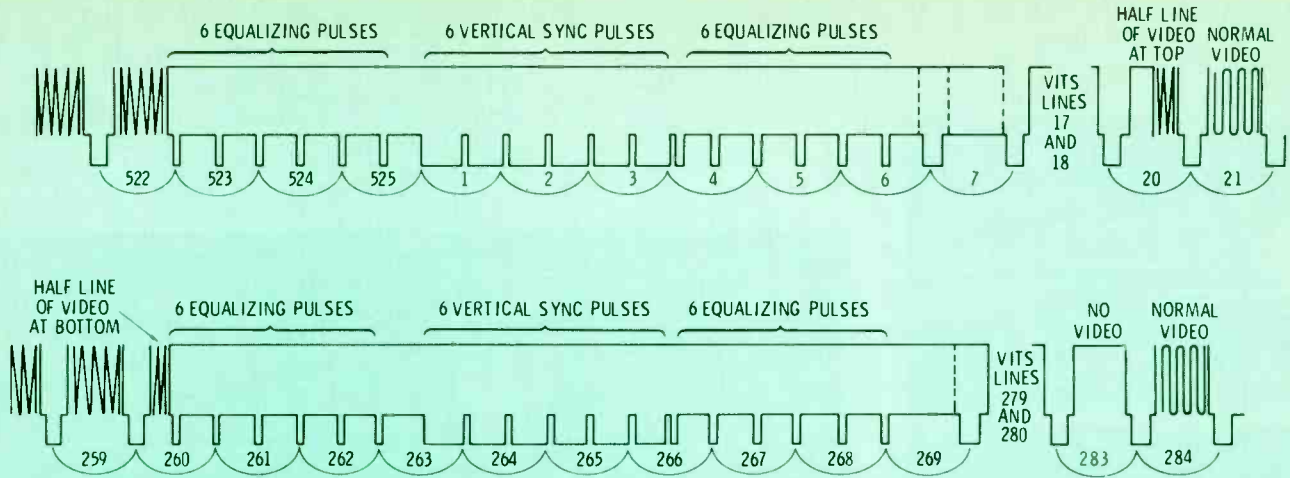
Those extra lines apparently were supposed to be in the video waveforms, although most drawings in the books don't show them.

### Lines In The Sync

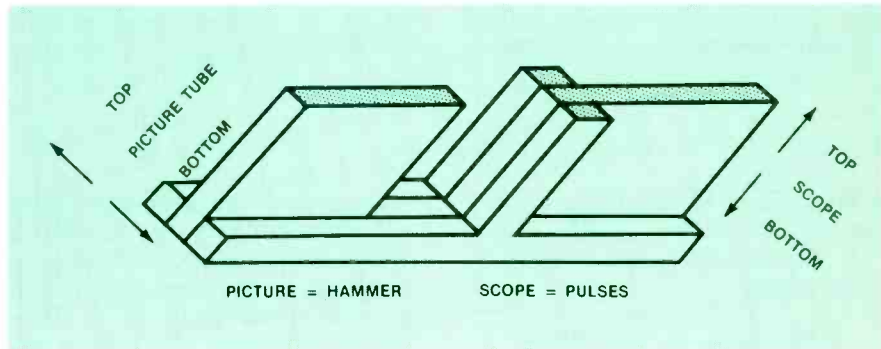
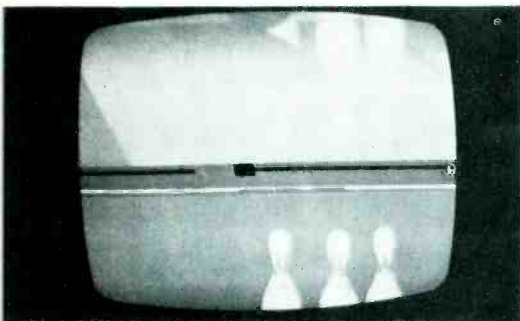
Next, I remembered seeing many spurious lines in the signals at the outputs of sync separators (Figure 2). Were they caused by the extra lines of the video waveforms? Part of the mystery was solved when I changed the scope to 2-millisecond-per-centimeter sweep and widened it with the X5 switch, producing the bottom waveform of Figure 2. Now it was plain that the extra lines in horizontal-rate waveforms were vertical sync and equalizing pulses, plus a small amplitude of vertical sweep.

### A Half Scanning Line?

But that wasn't the end of the questions. The specifications for TV are for 525 horizontal scanning lines each 1/30th of a second broken into two interlaced vertical fields as shown in Figure 3. According to that, each vertical field would have 262-1/2 scanning lines. It's impossible for the horizontal sweep system to produce a half



**Fig. 7** Drawing of negative-going video during the vertical-blanking period of both vertical fields. A few lines have been omitted to save space. Follow the line numbers of the two fields to see why there's only a half line space between the last equalizing pulse and the first horizontal sync pulse in field #1, but a full space in field #2. It's necessary to keep the TV horizontal oscillator firing correctly for the 262½ odd-number of lines of each vertical field. The waveform photo verifies the spacing of the pulses, and the location of the VITS waveforms.



**Fig. 8** The black "hammer" in the center of the screen shows that normal equalizing and vertical sync pulses are reaching the picture tube.

**Fig. 9** This drawing shows that the "tops" of the vertical pulses form the hammer in the picture, and the "sides" of the hammer are vertical sync and equalizing pulses when seen on a scope.

scan. Also, scope waveforms of the horizontal scan show **no** unexplained gaps or half lines. The vertical sweep, too, runs without any skips. Yet to see a half line on the TV screen, all you need to do is reduce the height at the top edge of the raster (see Figure 4). The top line is not complete; however, the beginning might be anywhere along the width. Although this appears to be proof of a half scanning line, it's not. The half line is produced by vertical blanking, not by partial scan.

### The Vertical Fields Aren't Identical

Analysis of both vertical fields viewed in the same single-trace waveform can't be accurate. That's because the two fields are not the same. Here's how to adjust a triggered-sweep scope to show both fields together: select a sweep of about 30 microseconds, X1 width, and single-trace operation. Using the internal sync separator set to "vertical TV", adjust the controls for a stable, locked waveform. The top waveform of Figure 5 is typical.

At the left are 5 of the 6 vertical sync pulses (one is required to lock the scope), next at the right are 6 narrow equalizing pulses, followed by several horizontal sync pulses.

When I first experimented with this method a couple of years ago, I was puzzled because the spacing between the various vertical sync and equalizing pulses apparently was the same as the spacing between the regular horizontal sync pulses. Yet the drawings in books showed these pulses to be twice as close. The reason for the discrepan-



cy is that both fields are shown at one time.

There are two ways of separating the fields for scope observation. First, we'll continue with the method already described. Change to double-trace and alternate-scan functions. Perhaps we should explain some scope terms.

A dual-beam scope has a double CRT with two sets of deflection plates, and can display two separate waveforms constantly. Double-trace or dual-trace scopes show two waveforms on a time-sharing basis. "Chop" mode samples the signal from the two vertical amplifiers by means of a square wave of (say) 100 kHz, and usually is done at slow scope sweep speeds. "Alternate" mode displays the waveform of Channel 1 during one horizontal scope scan, then the waveform of Channel 2 during the next, and the Channel 1 waveform again, etc. Each channel has its own centering control and gain controls.

Both chopped and alternating functions reduce the brightness of the trace, as does the X5 or X10 width expansion. Also, when only a part of one cycle is shown in order to expand the detail, the brightness is dimmed, because the trace is off longer than it is on. The trace occurs for the desired short period of time, then stops until the start of the next cycle of the waveform.

In this case, alternate sweep separates the two vertical fields,

showing the differences (Figure 5, bottom picture). Of course, probes of both Channel 1 and Channel 2 should be connected to the same point in the receiver, preferably at the video detector. Notice each of the two fields have 6 narrow post-equalizing pulses, but in the top trace there is only half a space between the last equalizing pulse and the first normal horizontal sync pulse. Also, the horizontal sync pulses are not lined up vertically, one directly above the other. They are alternated by half the space between sync pulses. That's done to eliminate the necessity for the horizontal deflection in the TV to give a half sweep at that point. Remember the 262-1/2 lines of each field. The next illustration should make this more clear.

#### Another way of separating fields

The scope adjustments just described provide an expanded view of the waveform following the vertical sync pulses, but not the pre-equalizing pulses that occur before the sync pulses. There is another way of showing the complete vertical interval of one field, plus some video on either side. Only one (never two together) of the TV vertical fields can be seen by this method.

Adjust the scope as required for the top picture of Figure 5, but set the scope time base for 2 milliseconds, and lock the waveform to

give about 1-1/2 vertical TV fields, including the first one used to trigger the scope. (The one on the left is one field, and the one on the right is the other; that's how you can be sure of viewing only one TV field, and not both together.) Then widen the trace with the X5 switch, and center the **second** vertical sync area, giving a waveform similar to that in Figure 6. Dual-trace operation doesn't help here, because both traces would show the same field.

However, chance determines **which** of the two vertical fields you see. Triggered-sweep scopes can lock on **either** vertical TV field, and hold it until the locking is interrupted. Next time, locking might be on either field. So, if you want to look at one certain field, you must throw the scope out of lock and back again, until the desired field is there.

#### TV Scanning Standards

Although I wanted to use actual waveforms instead of drawings, it seemed necessary to use the one of Figure 7 to give enough detail. Think of the problem this way: if we had a super scope that would show all 525 lines with each TV horizontal scan area occupying only 1/4 inch, the screen would be more than 131 inches wide!

All the important data in Figure 7A has been verified by observing many scope waveforms, and by

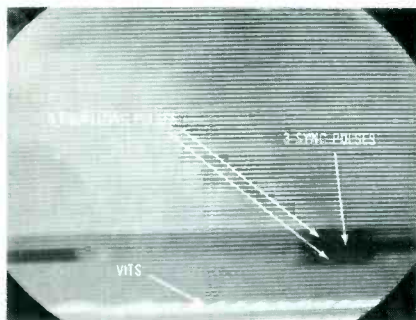


Fig. 10 Explanation of the various parts of the hammer, and the location of the VITS signals.

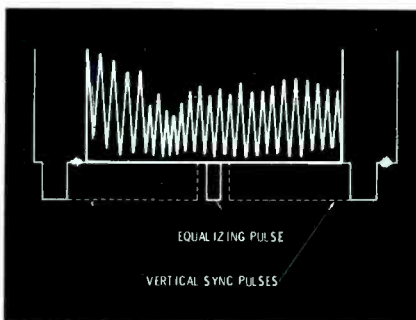


Fig. 11 The line connecting the shoulders of the horizontal blanking pulses is caused by the vertical blanking pulses present for about 46 of the 525 lines. 24 equalizing pulses and 12 vertical sync pulses also are there during each 1/30th of a second.

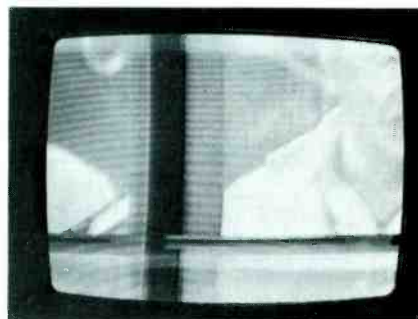


Fig. 12 A second hammer occurs during the horizontal retrace period, so normally it is not seen. This picture was taken by killing the horizontal sync and snapping the shutter as the bar drifted sideways.

checking against the EIA Standards for Monochrome TV, volume RS-170. However, considerable variations are permitted by the rules. For example, there can be anywhere from 9 to 12 horizontal scanning lines between the last post-equalizing pulse and the first scanning line having video. In some cases, I have seen the VITS signals on lines 16 and 17, while at other times they were on lines 17 and 18. Also, the half-blanked line of video isn't always on the same line, and the starting position varies considerably.

Actually, the strongest argument I know for the conventional interlaced-field theory is found by analyzing the drawing. Look at it this way: although the drawing and the scope waveforms show the horizontal sync pulses of the two fields offset (not above one another), we know for certain that the horizontal scanning lines as seen on the face of the picture tube **must** start at the same time so all vertical lines in the picture will be straight. Therefore, the implication is that the second vertical **field** starts just one-half the time of one scanning line either before or after that of the first field. In that case, the scanning lines of the two fields would be vertically separated by a distance the vertical sweep moves down the screen in half the time the TV horizontal sweep goes through trace and retrace. That's precisely the theory of interlaced vertical scanning.

Why, you well might ask, do I still persist in doubting that the actual scanning is interlaced? There are several strong reasons for that doubt.

### Analyzing The "Hammer"

For years, I have used the appearance of the so-called "hammer" on the screen of a picture tube as proof of whether or not the vertical sync pulses were normal in the video applied to the picture tube. The hammer is easy to see. Just reduce contrast, increase brightness, and roll the vertical locking so the picture drifts slowly downward (Figure 8). Obviously, the term comes from the resemblance to a

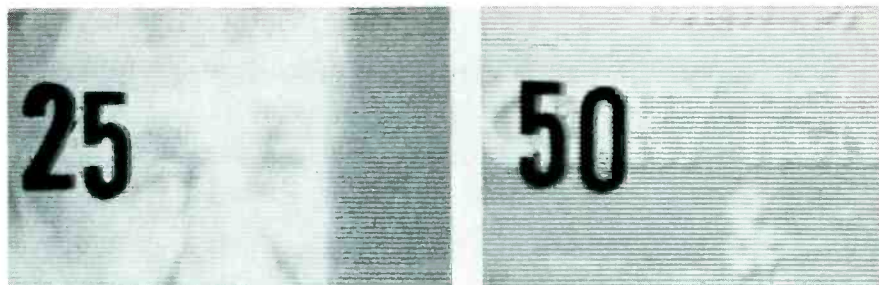


Fig. 13 Pictures taken at 1/50th second do not show half the scanning lines of those taken at 1/25th, although the white lines are slightly wider at 1/25th. This fact was verified by many dozens of photos.

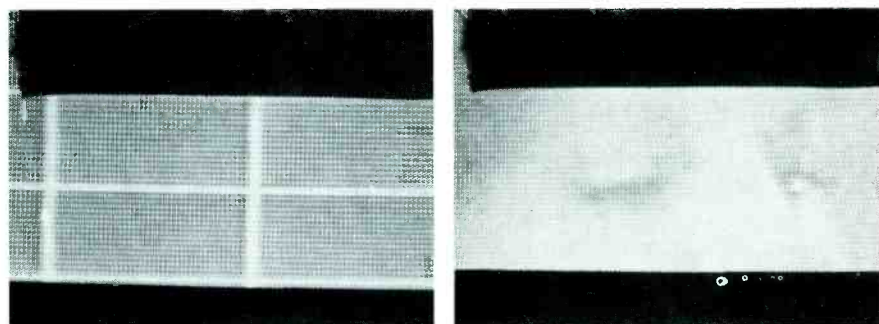


Fig. 14 These pictures show the same number of scanning lines both on crosshatch and for station signal. Multiplying number of crosshatch spaces by lines per space gave about 240 lines, just half the number called for by theory.

mallet with a long thin handle stretching out to the right.

The scope waveform of Figure 6 and the hammer are two representations of the same thing. That's hard to believe, but it's true. Perhaps the drawing of Figure 9 will help. Tilt the drawing clockwise, and the gray areas become the hammer as it would appear if you tilted a portable TV receiver towards the back and looked at the screen from the side.

But rotate the page counter-clockwise and each of the three pieces becomes a scope waveform, viewed from an angle. The front and rear segments each represents three narrow pre- or post-equalizing pulses, and the center one is actually two vertical sync pulses made up of three horizontal scanning lines.

Two more illustrations should help make the concept clear. In the hammer seen on the picture tube, six scanning lines paint the equalizing pulses and the center three show the vertical-sync pulses (Figure 10). The drawing of Figure 11 shows the equalizing pulses and

sync pulses in relationship to the normal horizontal sync pulses. These extra pulses are dim on a scope because they occur only 18 times out of the 525. That's the explanation for those extra lines in the video waveforms as seen on scopes.

Now, back to the question about interlacing of the two vertical fields. First, you must know that there are **two** hammers, not just one. One happens during the horizontal retrace time, as shown in Figure 12, and normally is invisible. Each vertical field is allocated **nine** horizontal scanning lines for equalizing and vertical sync pulses. Therefore, **if the scanning is interlaced, 18 scanning lines on the picture tube should have equalizing or vertical sync pulses. Count them, and you will find only nine!**

You might question (as I did) the possibility that forcing the vertical out of lock in order to view the hammer might destroy the interlace. If that were true, the screen should show twice as many scanning lines with the picture locked



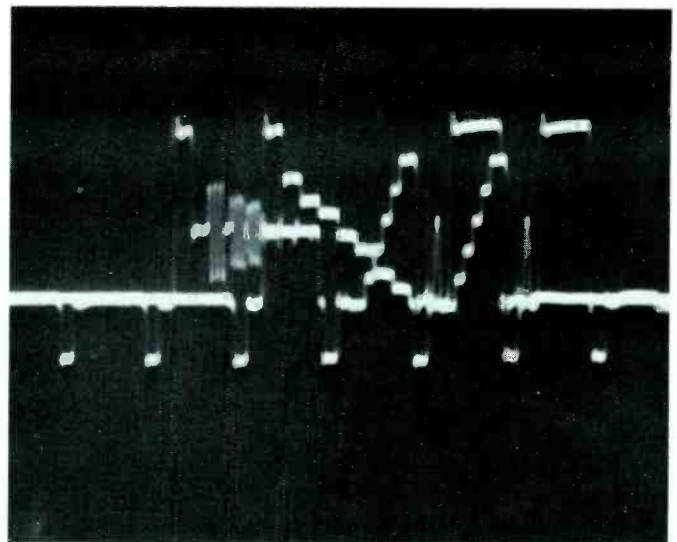
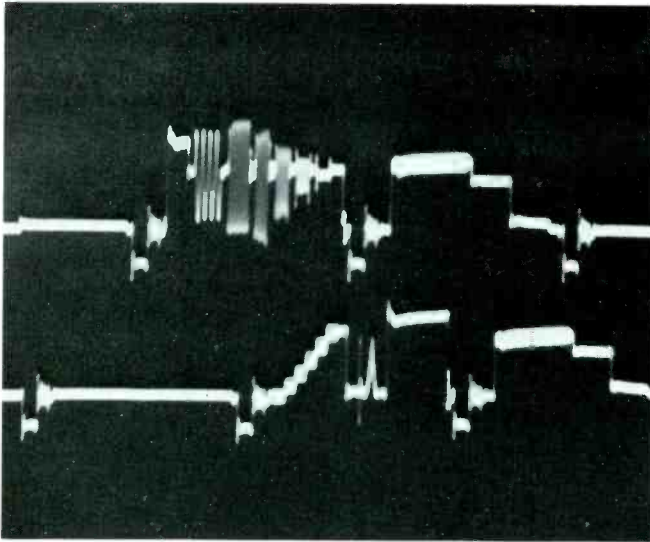


Fig. 15 Picture at left shows the two fields with VITS separated by dual-trace scope operation. Right picture shows how VITS looks on a single trace.

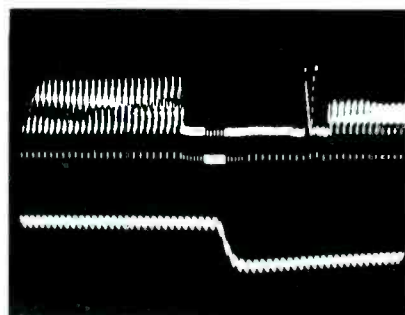
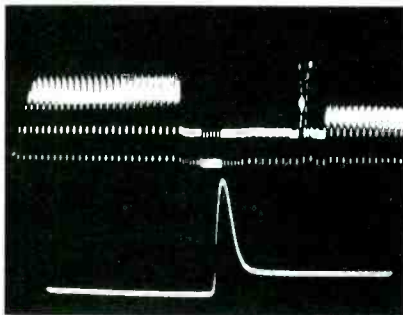


Fig. 16 Vertical-blanking section of negative-going video compared to a vertical deflection pulse (left photo) shows why such a narrow pulse (when used to supplement the vertical blanking in older color sets) did not blank out the entire retrace period. Picture at right shows the video and the yoke current during retrace. Only yoke current drops when retrace occurs.

as it does when rolling downward. A careful examination of the raster lines showed no difference in number whether locked or not.

### Photographic Evidence

If 1/30th of a second (two 60-Hz fields) is required to give a complete picture by interlaced scanning, then a picture taken at 1/60th of a second should show only every other scanning line on the raster. Except for any possible errors caused by phosphorus afterglow, this sounds very reasonable. One caution: cameras that have focal-plane shutters usually produce broad diagonal bars across pictures taken from TV screens. The cause is a reaction between camera "scanning" and TV scanning, and the bars can be minimized by using a shutter speed of 1/15 second or slower. To avoid this problem, I used only cameras with iris-type shutters.

The photographs of Figure 13 give no evidence that alternate scanning lines are lost because of short camera exposures. Another bit of evidence against interlaced scanning.

### How Many Visible Scanning Lines?

Scanning specifications permit no more than 7.5% of the scanning lines to be blacked out by the vertical blanking pedestal. Therefore, about 480 scanning lines should be visible on the screen of a sharply-focused, properly-locked TV receiver. Did you ever count the lines? Neither did I, before my suspicions about interlacing were aroused by other facts.

Because it's too difficult to count all the scanning lines of an entire picture, I did the easy thing: counted a known part and then multiplied. A crosshatch pattern, by its very nature, represents the same amount

of time between each adjacent pair of horizontal bars. Therefore, the same number of scanning lines must be found between each pair of bars.

If you have followed these points carefully, you're probably remembering that dot-bar generators don't promise interlaced scanning. To eliminate that possible error, I locked the crosshatch pattern on the screen, applied plastic tape to mark the height of **two** bars, and counted the number of scanning lines between the pieces of tape. Then I tuned in a TV station, and again counted the number of scanning lines between the pieces of tape. Both the generator and the station produced the **same** apparent number of scanning lines (Figure 14). There was a slight difference in sharpness of the lines, but the brightness was not precisely the same, either.

Multiplying the number of lines

between the pieces of tape by one half the total number of spaces between all the crosshatch bars gave 246 lines; just half as many as expected, if the scanning had been interlaced.

### VITS

Vertical-Interval Test Signals (VITS) are added to the unused scanning lines located between the post-equalizing pulses and the start of the video. They can be seen as white lines at the top of a TV picture if you slightly reduce the height. However, it's not very practical to analyze them from the TV screen. For one reason, the four VITS waveforms **appear** to be on either two or three of the scanning lines. They overlap; another point against the possibility of interlacing.

These VITS waveforms are generated and added to the video signal by equipment of the TV networks (probably at AT&T long-lines offices) as a tool for rapid evaluation of video frequency response and amplitude linearity. At any step of the video journey across the country, network engineers can use special scopes designed to lock only the lines showing the VITS waveforms.

I have observed several variations of VITS, depending on the particular network involved. Usually, locally-originated programs do not have the VITS signals. Figure 15 shows separate dual-trace VITS waveforms compared to the overlapped effect when the two fields are displayed on a single trace.

Theoretically, it's possible for us to connect a scope to the video detector of a TV receiver and determine from the VITS signals the overall frequency response of the receiver. In practice, this is difficult. For one thing, the result is the total of the network bandwidth added to that of the receiver. Also, it's difficult to know the frequency of the various bursts; without that knowledge you can't do more than guess.

Of course, if you always view the VITS from the same network and over the same local station, eventually you might become familiar with what response to expect from normal receivers. But use care in setting the fine tuning the same

each time, otherwise the results will mean nothing. Another limitation is that color characteristics are not tested. I still believe that an analysis of the color bars will reveal far more about the condition of a receiver than is possible with VITS.

### Retrace Versus Blanking

No more than 7.5% of the scanning lines are permitted to be blacked out by the vertical-blanking signal. Therefore, any retrace from the bottom of the screen back to the top that exceeds this time limit would produce a white haze or an inverted picture superimposed on the top or bottom of the picture.

With non-defective receivers, retrace is much faster than necessary to prevent such retrace ghosts. There is another advantage. Any non-linearity of the sweep is more likely at the start of the scan, and having several invisible lines before any video is applied gives time enough for ringing or overshoot to die down before the picture begins.

Capacitance across the vertical yoke circuit tends to slow down the retrace and lowers the ringing frequency. Some vertical circuits have capacitors across the vertical output transformers or the yokes, and the linearity of the top inch or so of the picture can be tailored by selection of a slightly-different value. This applies mainly to b-w sets; color receivers seldom need any improvement.

There's only one way to be certain when vertical retrace begins and when it ends. And that is to use a dual-trace scope, simultaneously looking at the video waveform and the vertical yoke current. The waveforms of Figure 16 show video phase relative both to the yoke current (best indicator of retrace) and to the vertical pulses caused by the collapsing field of the yoke. Retrace usually is completed by the last of the post-equalizing pulses.

One practical benefit from these bits of theoretical knowledge is to explain why some of the simple retrace-blanking circuits in older color receivers don't eliminate all of the retrace lines in the picture. Notice in Figure 16 that the peak of the vertical pulse has passed before the end of vertical retrace. There-

fore, part of the retrace is not completely blanked. Some receivers clip and broaden this vertical pulse in order to provide better retrace blanking in the receiver.

### Summary

At this time, I am convinced that interlaced vertical scanning (while apparently true in theory) does not occur in actual reception of TV programs.

Or, if it does occur, the corresponding lines of the two fields are not separated enough to be seen as two lines on the screen of a picture tube. It is possible the combined line is broader than a single line would be. Scanning lines are not that easy to see and analyze, although I examined them on three color sets and one b-w.

I talked to the chief design engineer of a company which manufactures sync generators for networks and TV stations. He was convinced that the TV fields do interlace, but offhand couldn't think of any test equipment available to me that would provide positive proof. He referred me to the Electronic Industries Association (EIA) monochrome standards bulletin RS-170. I sent for one, but it was a big disappointment. For although that authoritative source showed a drawing of the equalizing and vertical sync pulses (somewhat similar to Figure 7), it didn't mention interlaced scanning, or even say how many lines there should be!

My experiences illustrate some of the difficulties a technician encounters if he wants to proceed farther than the bare bones of the text books, especially since so many mistakes apparently have crept in by one author copying another, over and over again.

Although I have gone to considerable trouble to collect all these facts and waveforms, I remain open to other theories or different interpretations of the facts. I shall be happy to receive your letter, but please don't refer me to some drawing or unsupported statement in a text book or TV course.

Can you prove whether or not vertical fields are interlaced?



# New life for the old test jig.



## Make it a solid-state tester with our new Sylvania Rig-A-Jig™ CK1900X.

The old test jig you used with tube-set chassis can work full time again. Connect the new Sylvania Rig-A-Jig CK1900X to it and *presto*—you have a test jig for solid-state and hybrid TV as well.

The Rig-A-Jig CK1900X has a self-contained anode voltmeter, a complete set of yoke programmers, and an internal focus supply.

And, it will give you a close impedance match in receiver deflection circuits for almost any hybrid or solid-state sets you might have to service. And these connections are easy to make with up-front, highly accessible receptacles.

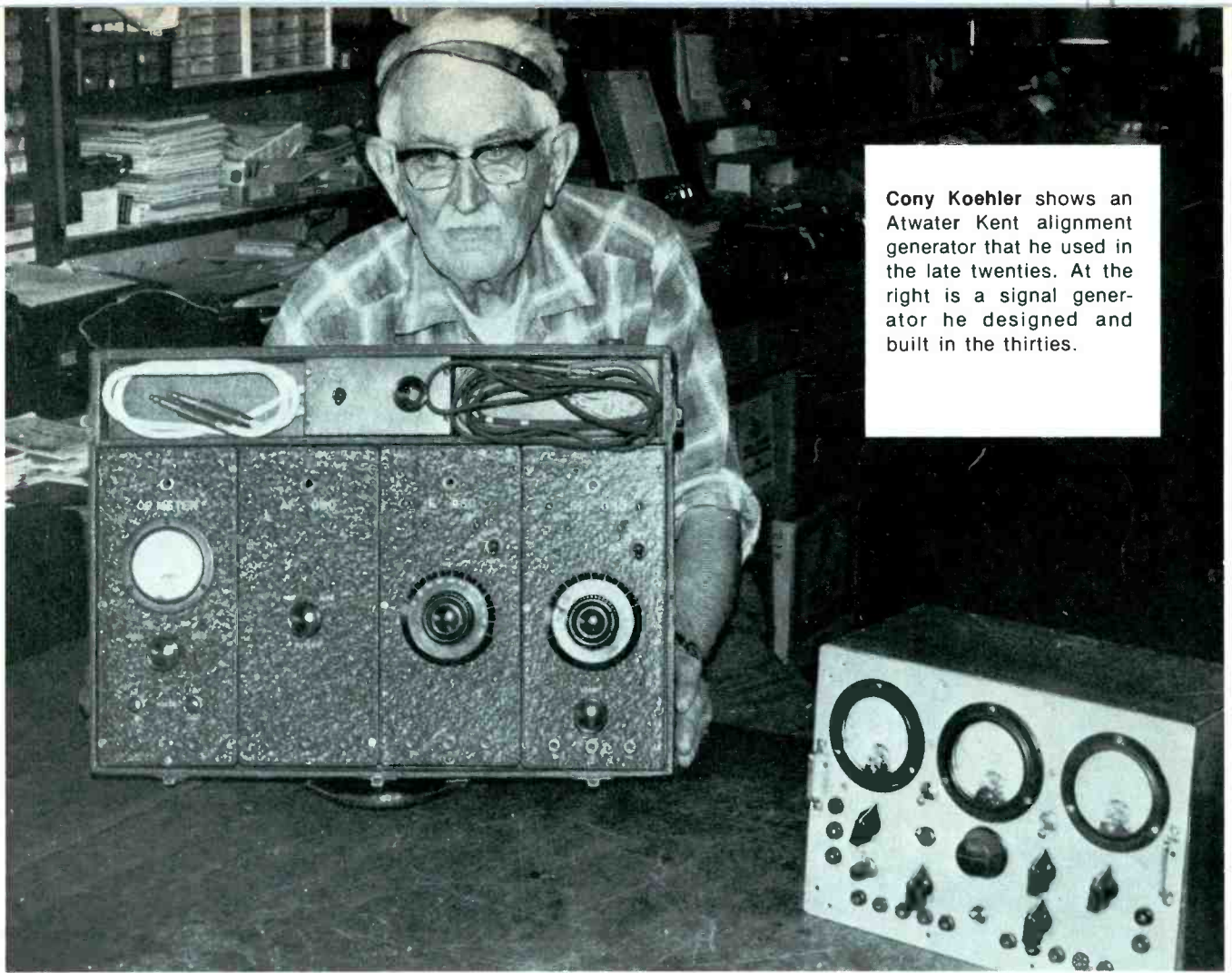
With simple modifications, you can give new life to your old test jig so it can handle sets with 350 to 500  $\mu$ H SCR sweep, 1 and 3 mH for transformer sweep, or tube and hybrid sets with yoke inductances from 7, 12, and 16 mH. Instruction sheets and set-up manual are also included.

Ask your Sylvania distributor for more information.

Rig-A-Jig CK1900X. The newest addition to the versatile family of Chek-A-Color™ Test Equipment.

**GTE SYLVANIA**

GTE Sylvania, Electronic Components Group,  
100 First Avenue, Waltham, Mass. 02154.



Cony Koehler shows an Atwater Kent alignment generator that he used in the late twenties. At the right is a signal generator he designed and built in the thirties.

# 67 years of "Know-How"

By Bill Manny, CET

*In this context, know-how is a combination of technical education, practical experience, hard work, ambition, ethical business practices, and pride of workmanship. We can all learn from this "rugged" individualist, who was servicing electronic equipment before most of us were born.*

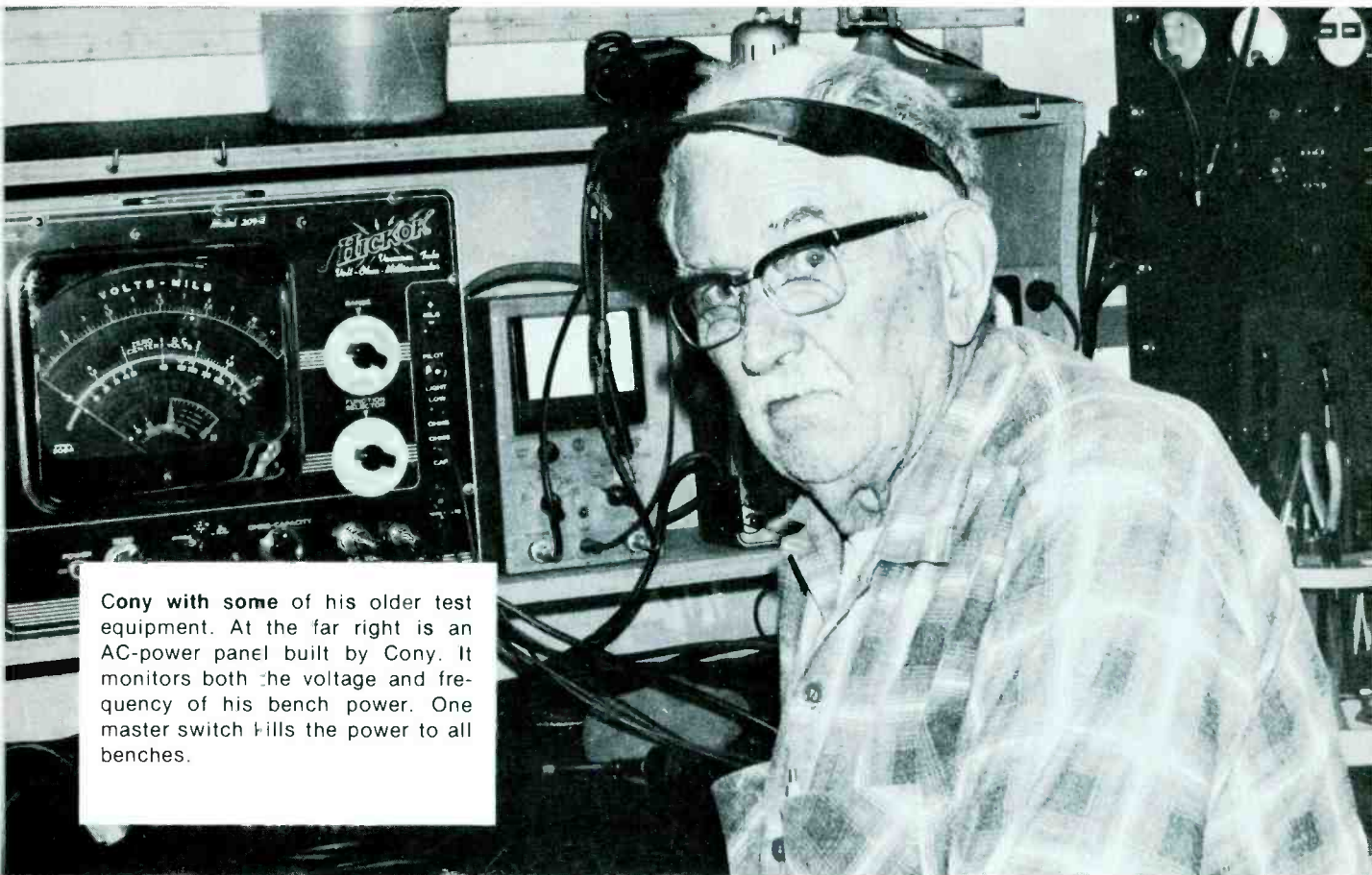
**At the age of eighty-three, Cony Koehler is witty, alert, and blunt-spoken.** No rocking chair, knitted shawl, or cup of sassafras tea for this octogenarian; he owns and operates Koehler's Radio and TV in Baker, Oregon, a pleasant community of 10,000 people.

I'd called Cony and gotten an okay to stop by, ask a few questions,



All test equipment, tools, adapters and cables on this bench are for radio repairs alone.





Cony with some of his older test equipment. At the far right is an AC-power panel built by Cony. It monitors both the voltage and frequency of his bench power. One master switch kills the power to all benches.

and take some pictures. When I walked in, Cony was at the bench, ferreting out a problem in a solid-state car radio. "Come on back," he shouted, tugging at the black-banded eye-shade that partially hid his bushy thatch of white hair. "Let's get this over with—I'm busier than a one-armed paper hanger!"

That's Cony Koehler. Sixty seven years ago, as a big, bright lad of sixteen, Cony contracted to do the electrical wiring in two Baker homes. He did the jobs well, always a Koehler trademark. His pay? Two dollars per house, plus parts. One year later, in 1908, he designed and built a radio receiver and a rotary spark-gap type wireless transmitter. Thus began his life-long love affair with electronics.

**His service career since then has spanned six decades.** In the early years he did electrical work of all kinds—wiring, motor and generator

repairing—at the same time growing up with the infant electronics industry. He did repairs on wireless, crystal sets and TRF's, then super-hets, and on into television and modern solid-state. His service-call conveyances have progressed from horse and buggy to motorcycle to Model A, and then through various post-WW2 vehicles to his present 1973 four-wheel-drive rig that doubles as hunting and fishing transportation. Twice a widower, he makes only one concession to his age: a hearing aid. He still works an eight-hour day.

How does he do it? How can he run a one-man shop at the age of eighty-three? Well, I asked him that question.

"Come on," he said, his walrus-like, salt and pepper moustache bouncing with each word. "I'll give you the nickel tour of the shop while we talk."

He pointed out the bench where

he'd been working when I came in. It was outfitted for radio work only—with a VTVM, a signal generator, a homemade signal tracer, an old scope, and all sorts of associated leads, adapters, and dummy harnesses.

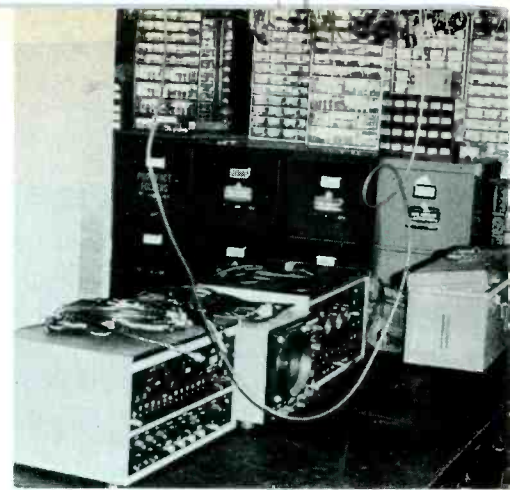
Farther down was a bench for such mechanical monsters as tape transports, cassettes, and phono changers. Appropriate tools and gadgets were laid out neatly.

**"Efficiency," Cony said. "That's the ticket."** Then, he motioned me across the shop into the television area. The TV bench was twenty-feet long, with two rows of test-equipment shelves behind it. Among other gear, I spotted a new FET-transistor checker, a digital voltmeter, and a triggered-sweep scope. On an old roll-around desk sat a post-injection video-sweep generator, another triggered scope, and the latest Analyst.

"Efficiency," repeated Cony.

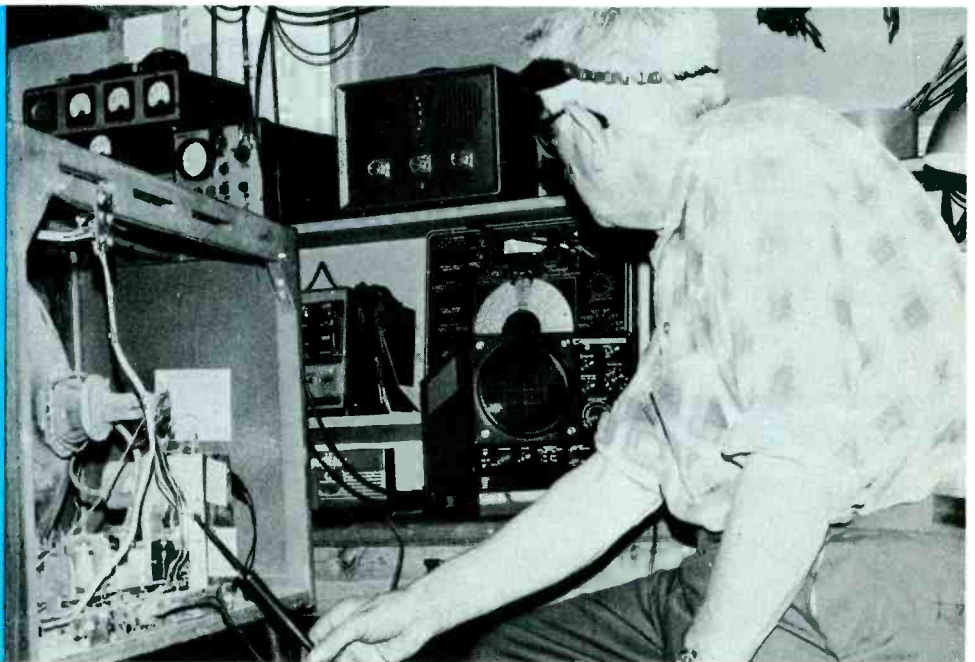


Just one corner of the extensive parts room. All the bins are marked, and the parts are cross-filed by brand and item.



Here's some of the modern test equipment, including post-injection sweep generator, and triggered-sweep scope. File cabinets are filled with Photofact folders.

A triggered-sweep scope is a necessity, Cony feels, for checking horizontal waveforms.



"And you must have good test equipment. Modern sweep gear can show you a response curve in a few extra minutes. There's no excuse in this day and age for sloppy workmanship. No, sir!"

No wonder some of Cony's repeat business comes from as far away as a hundred and fifty miles.

"Speaking of test equipment," he said, chuckling, "ever seen one of these?" He pulled a brown cabinet from under a bench and popped the lid off. "Alignment gear built by Atwater-Kent for aligning TRF's. Used it in the later twenties and early thirties."

I had to admit I'd never seen one. But, he'd made his point. Good test equipment was as important to Cony's one-man shop in

the 1920's as it is now in the 1970's.

Next, Cony led me into his parts room. Here again, organization was exceptional. One wall was covered by tube shelves from floor to ceiling. The other walls were hidden behind huge cabinets built by Cony, with each cabinet divided into different-sized compartments. Large doors covered the sections containing filters, sweep components, and other bulky parts. Below the large compartments were drawers with individually-marked bins, cross-filed by brand and/or item.

How does the system work? Cony showed me. Suppose he needed a 6350 Miller focus coil. He'd go first to his master file and pull out the

index. There he'd find drawer number, bin number, and quantity in stock. If he used one, he'd change the stock quantity and order the replacement. Time consuming to set up? Sure. But you can bet it's convenient, especially when Cony has only a couple of distributors within two hundred miles. And, as Cony explained, once the system was organized it was easy to maintain.

"Something else to show you," he said, leading me through what used to be his back door. I found myself in an open-beamed room about thirty-feet square. "I needed more room," he said. "I'm going to put a bench on one side and use the other side for a set-cooking area."

I just stared at him. Not only



does he run a large one-man shop at eighty-three—he's expanding! And naturally, he did the wiring himself. But without the porcelain insulators and wire cleats he'd first used in 1907.

Back inside the main shop, Cony sat down at the radio bench. I asked him what factor he felt was mainly responsible for his long-term success.

"Plain old know-how," he said. "All that equipment is worthless unless you know how to use it. And to keep up-to-date, you have to love electronics. You have to study; aptitude alone is not enough. My father got me the best electrical correspondence-school course there was back in 1906. I was still in high school and reading every book on electrical engineering I could get. And I still read the technical magazines to stay up on solid-state." He laughed, a big, hearty burst of

sound. "Besides, I have to stay ahead of the **twiddlers**."

**Twiddler** turned out to be a Koehlerism for a technician who plugs in a couple of tubes and, if that doesn't fix the set, he **twiddles** with every single adjustment. Cony made it very plain. He has little love for **twiddlers**.

Half an hour later, my pictures taken, I gathered up my gear. Cony was busy on a color set, which prompted one last question: how did he do the heavy lifting required for moving television sets? Cony admitted he sometimes borrowed outside muscle, just as almost all one-man shops do from time to time.

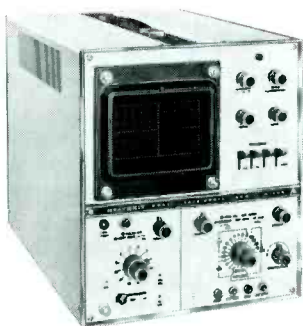
Before I left Baker, I talked to Cony's cousin, Constance White, a mere youngster of seventy-eight, who answers Cony's phone when he's out of the shop. She's a de-

lightful person who told me that Cony was successful because he had always done top-notch work at reasonable prices. "He always was just a natural at anything electronic," she said.

I had to agree. **Who could argue with sixty-seven years of "plain old know-how?"**



## Looking for a dependable service scope with wide bandwidth and a low price? Heath has two.



### Single trace.

If you need a precise, dependable service bench scope, then the Heathkit IO-104 is the one for you. It features DC-15 MHz bandwidth...10 mV/cm to 50 V/cm input sensitivity...22 time bases from 2 s/cm to 0.2  $\mu$ s/cm ...normal or automatic trigger modes...AC or DC coupling...built-in calibrator to insure accurate frequency and amplitude measurements. For reliability

and top sensitivity at a sensible price, put the Heathkit IO-104 on your bench.

Kit IO-104, 44 lbs., mailable ..... **329.95\***



### Dual trace.

The Heathkit IO-105 will put complete dual trace measurement capability on your bench. Two separate input signals can be displayed separately or, in the Alternate and Chopped modes, simultaneously for direct comparison. In the X-Y mode, the two channels are displayed as a function of each other. Vertical sensitivity is 50 mV/cm, AC or DC. Bandwidth

is DC-15 MHz. An 18-position time base control selects rates from 100 ms/cm to 20 ns/cm. Switch-selected AC or DC coupling.

Kit IO-105, 40 lbs., mailable ..... **429.95\***

Send for your **FREE '75 Heathkit Catalog** and find out about our complete line of instrument values

A complete line of test and service instruments is described in the free '75 Heathkit Catalog — frequency counters, DVMs, power supplies, generators, TV & audio service gear and more. Every instrument is designed for a maximum of performance at low cost. Compare us with the competition—you won't find better values than instruments from Heath.



<b>HEATH COMPANY</b>		<b>HEATH</b>	
Dept. 25-8		Schlumberger	
Benton Harbor, Michigan 49022			
<input type="checkbox"/> Please send FREE Heathkit Catalog.			
<input type="checkbox"/> Please send model(s) _____			
Enclosed is \$ _____ plus shipping.			
Name _____			
Address _____			
City _____ State _____ Zip _____			
*Mail order prices; F.O.B. factory.			
Prices & specifications subject to change without notice. TE-310			

For More Details Circle (10) on Reply Card

# A TV Instructor Advises Beginners

By Kenneth T. Deschler, CET



*To be successful, every TV technician should practice a logical sequence of troubleshooting tests, which are based on his knowledge of how the circuits operate. The author, a tech school instructor, gives good advice primarily for inexperienced technicians. However, even old-timers should find the information to be helpful as a refresher course.*

Every competent TV technician should be an electronic detective. After starting with the facts that are known, he searches for more clues, and finally has enough information to close the case. Compared to a detective solving crimes, technicians have some good news, and some bad news (as they say on TV). The good news is that the defect can be crosschecked after it is located. On the bad news side, electronic parts can't confess or volunteer information. Facts must be obtained the hard way. Modern TV receivers are so complicated that technicians need all the help they can get. The following sequence is designed to gather the most facts of a useful nature in the shortest period of time.

## Logical Troubleshooting

During each repair, run down the following checklist. Skip over any that don't seem to apply in any specific case.

### Assume one trouble

Although any individual TV receiver might have many separate defects, you should troubleshoot as though there were only one. If the symptoms point toward several

troubles, choose the most prominent one and check on it first. If replacement of parts eliminates one of the symptoms, but not others, then test for additional defects. **Attack each defect one by one, until no wrong symptoms remain.** The bonus is that often replacement of only one part eliminates several apparently-unrelated symptoms.

### Get facts from customers

Much useful data can be obtained from the set owner, even though you must translate laymen's terms and viewpoints into technical language.

For example, the customer might say the picture has lines or streaks in it. You should inquire whether the lines are white or black or in color, when they appear, what they look like, and whether they are there instead of the picture or superimposed over it.

Also, ask about previous repairs, and what the symptoms were then. If the symptoms before were completely different, probably you don't need to consider those repairs as important to the present one. On the other hand, if the previous repairs didn't relieve the symptoms

at any time, you can cross off those parts replaced as possible sources of the trouble.

### Locating the defective circuit

For each TV receiver, you should have in mind a block diagram of the basic circuits. Also, you should know what the circuits in each block are supposed to do, and what results to expect from adjustments of any controls.

When the machines are complex, it's necessary to divide them into smaller, more-manageable sections. Ask yourself this question: "Which of those basic circuits **could** cause the symptoms?" Perhaps in answer you will list several blocks, or only one. Then, concentrate on the area or areas that are under suspicion.

### Visual and manipulation tests

**Always perform a visual inspection of the suspected area.** You won't see anything wrong every time, but it's certainly worthwhile when you do. Look for such things as burned resistors, broken wires or components, unlit or red-plate tubes, unplugged transistors, or cracked circuit boards.

Other mechanical tests involve tapping components with a rubber hammer or the handle of an insulated screwdriver. Find the one part most sensitive to vibration.

Don't touch any alignment cores, but adjust any controls which might have a bearing on the malfunction. Examples are contrast and AGC controls for video or contrast troubles, or vertical height and linearity controls for vertical problems. Unless these adjustments have been tampered with, only slight movements in both directions should be enough to prove the point, or show any bad spots on the control elements. Don't adjust any more than necessary.

### Test by replacement

Tubes and plug-in transistors in the suspected circuit should be removed for testing, or replaced by ones known to be good. Keep in mind that vertical and horizontal

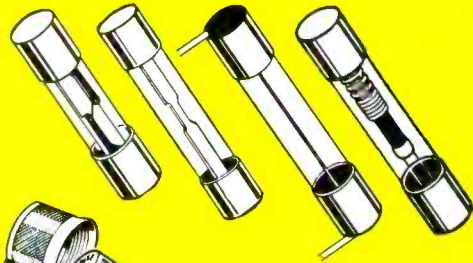


# The Single Source For Reliable Protection For Every Type Of Electronic And Electrical Circuit And Device

# BUSS<sup>®</sup>

## SMALL DIMENSION FUSES AND FUSEHOLDERS

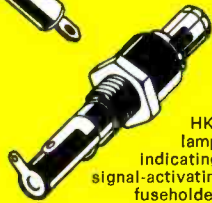
Include dual-element "slow-blowing" fuses, single-element "quick-acting" fuses and signal or visual indicating type fuses . . . in sizes from 1/500 amp. up . . . PLUS: a companion line of fuseholders.



HMR — RF shielded fuseholder for 1/4 x 1 1/4 in. fuses.



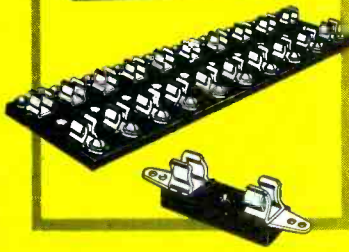
HKP panel mounted fuseholder for 1/4 x 1 1/4 in. fuse.



HKA lamp-indicating, signal-activating fuseholder.

### BLOCKS FOR BUSS FUSES

All types available for every application. Single pole, multiple pole, small base, full base, molded base, laminated base, porcelain base for fuses from 1/4 x 5/8 inches up. Also signal fuse blocks and special blocks of all types.



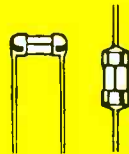
### TRON<sup>®</sup> Rectifier Fuses For the Safe Protection of Solid State Devices

Provide extremely fast opening on overload and fault currents, with a high degree of restriction of let-thru current. Many types and sizes available. Ampere ratings from 1/2 to 1000 in voltages up to 1500.

**BUSS SNAP-LOCK FUSE-HOLDER** — Rear panel-mounted fuseholder for 1/4 x 1 1/4" fuses. Snaps into place. Specify HTA-00 for space-saver type, HLD-00 for visual-indicating type, HKP-00 for standard fuseholder, or HJM-00 for 1/4 x 1" fuses.



**SUB-MINIATURE FUSE**—Ideal for space tight applications, light weight, vibration and shock resistant. For use as part of miniaturized integrated circuit, large multi-circuit electronic systems, computers, printed circuit boards, all electronic circuitry.



**TRON Sub-Miniature Pigtail Fuses** — Body size only .145 x .300 inches. Glass tube construction permits visual inspection of element. Hermetically sealed. Twenty-three ampere sizes from 1/100 thru 15.



**BUSS Sub-Miniature GMW Fuse and HWA Fuseholder.** Fuse size only .270 x .250 inches. Fuse has window for visual inspection of element. Fuse may be used with or without holder. 1/200 to 5 amp. Fuses and holders meet Military Specifications.

### THE COMPLETE LINE OF SIGNAL-INDICATING ALARM-ACTIVATING FUSES

For use on computers, microwave units, communication equipment, all electronic circuitry.



BUSS GLD 1/4 x 1 1/4 in. Visual-Indicating, Alarm-Activating.

BUSS GBA 1/4 x 1 1/4 in. Visual-Indicating



BUSS MIN 13/32 x 1 1/2 in. Visual-Indicating.

BUSS MIC 13/32 x 1 1/2 in. Visual-Indicating, Alarm-Activating.



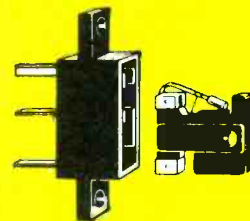
FNA FUSETRON<sup>®</sup> dual-element Fuse 13/32 x 1 1/2 in. slow-blowing, Visual-Indicating, Alarm-Activating. (Also useful for protection of small motors, solenoids, transformers in machine tool industry.)



BUSS Grasshopper Fuse, Visual-Indicating, Alarm-Activating.



BUSS ACH Aircraft Limiter, Visual-Indicating.



BUSS GMT and HLT holder, Visual-Indicating, Alarm-Activating.

FOR MORE INFORMATION ON THE COMPLETE BUSS LINE, WRITE FOR BUSS FORM SFB.



BUSSMANN MANUFACTURING  
a McGraw-Edison Company Division  
St. Louis, Missouri 63107

SUPPLIED THE ECONOMICAL WAY  
THRU DISTRIBUTORS  
**BUSS<sup>®</sup> FUSES**  
THE QUALITY LINE

tubes often can't be evaluated adequately in tube testers. In those cases, replacement is advisable.

In-circuit testing of soldered transistors can be done at this time, or it can be delayed until other tests indicate they might be bad.

#### Signal tracing tests

Some circuits are most easily and accurately evaluated by checking input and output waveforms using a scope. Vertical and horizontal sweep, audio, video, sync, and AGC stages are some examples. If the correct amplitude and waveform of signal appears at the input of the stage, but a distorted or weak output signal is found, it's obvious the trouble is located between those two points of the circuit.

#### Signal injection tests

The opposite way of finding the exact stage where a malfunction occurs is to inject a signal from test equipment into a stage near the picture tube, then work a stage at a time toward the antenna until the defective stage is located.

Both signal-tracing and signal-injection tests can be definite and helpful. The choice depends on the test equipment you have available, and your personal preference.

#### Voltage and resistance tests

Tests of resistances and DC voltages of a circuit usually should be done only after other tests have pinpointed the one stage where the defect is located.

In some cases, an analysis of DC voltages can lead to a rapid and accurate diagnosis. At other times, the results can be misleading, depending on the circumstances. A slight deviation from the schematic voltage might result from a normal variation of component tolerances, and thus not be important. But a collector or plate without **any** DC voltage is important and should be followed up without fail.

#### Out-of-circuit tests of parts

Any part which, after preliminary in-circuit tests, is suspected of being defective should be removed from the chassis and checked again separately. This is insurance against wrong decisions made because other components produced false

readings. Resistance tests of circuits having solid-state components are especially prone to wrong readings because the junctions conduct on any forward-bias voltage exceeding .5 volt for silicon or .1 volt for germanium.

#### Tests by replacement

The desired conclusion of all these tests is replacement of one or more components which restores normal operation of the receiver.

In some borderline cases, it's necessary actually to replace a suspected part before you can know for certain if it is defective. However, such replacements should be rare, if you do all the suggested tests first. There always is a danger, either to the receiver or to the component itself, when a part is removed for testing. Also, "shot-gunning" (replacement of all parts in a circuit) should not be done except as a **last resort** after all else has failed.

#### Removing Solid-State Components

One of the most intricate and frustrating jobs is removing and replacing solid-state components which are soldered to circuit boards.

The first problem is a physical one involving the small sizes of parts and the copper wires on the boards. Of course, the difficulties can be minimized by good lighting for better visibility, small tools, and the use of magnifying devices. But care still is required.

#### Beware of excessive heat

Excessive heat used during soldering **can** damage both the boards and the solid-state devices mounted on them. Also, a transistor hot from soldering frequently will not operate correctly until it cools; this might mislead you into believing it is defective.

In my experience, a 40-watt mid-geet iron seems to produce too much heat for board soldering. Around 20 to 25 watts is sufficient for good joints without damaging the boards.

A pair of pliers used to grasp the leads of a transistor or diode during soldering acts as a heat sink to dissipate the heat faster. Or the body of the component can be

sprayed with canned coolant just before the leads are soldered. I have used this latter method with good success.

Circuit boards can be damaged seriously by excessive heat which melts the adhesive holding the copper foil to the board, allowing the foil to pull away and break. Of course, small pieces of bus wire can be soldered in place to supplement broken segments of foil or to bridge an open circuit, but this must be considered a method of last resort. **It's much better not to damage the board.**

#### Removing solder

Another problem is removing old solder from a joint so the leads of a component can be pulled from the board. Of course, some solder clings to the tip during desoldering, but the amount is not sufficient; too much solder remains. Air pressure or a stiff brush can be used to remove the solder while it is molten, but there is danger the fragments might lodge between sections of the wiring, causing hard-to-find shorts.

Tools that suck up the molten solder are quite helpful. The device is compressed, the tip of the tube is placed against the hot solder, and the pressure released. This creates a vacuum which pulls the liquid solder up into the body of the device.

Another effective method is to use stranded bare wire or braided shielding impregnated with flux placed over the joint and heated with the tip of the iron until the solder melts. The solder flows into the crevices of the braid in wick-like fashion, then the saturated end of the braid is cut off and discarded. You should repeat the operation until sufficient solder has been removed.

When resoldering a joint, be sure the iron has reached maximum temperature, and that the tip is well-tinned. Touch the tip to the **joint**, and then add the solder **between** the tip and the joint. Don't melt solder on the tip, and transfer it to the joint; such solder will be brittle and rough. The iron must be hot enough that you can do the joint rapidly, and remove the iron quickly. If your iron is too hot,



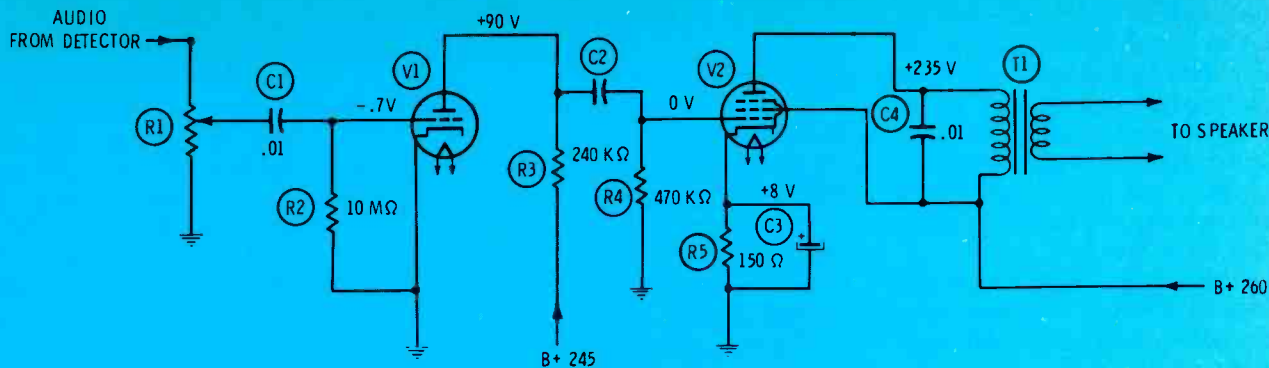


Fig. 1 Schematic of a two-stage audio amplifier used for examples of troubleshooting.

reduce the voltage with a variable auto-former (perhaps to between 70 and 100 volts). These are the basic rules for soldering to circuit boards.

### Loading By Test Equipment

In many cases, attaching test equipment to a circuit changes the characteristics too much for the results to be accurate. Some combinations of equipment and circuit are less successful than others. For example, a demodulator probe (or even a low-capacitance one) seriously detunes any IF stage to which it is connected. Of course, such a test might have some value if you make allowances for the detuning, although the signal certainly is distorted during the test.

On the other hand, a scope can be connected to low-impedance or untuned stages without any serious deterioration of the signal.

DC voltages, too, can be altered drastically by loading from a meter. The amount of error depends on the internal resistance of the meter versus the resistance of the circuit. The problem is further complicated because some meters have a different internal resistance for each range. In addition, it isn't always easy to know the resistivity of the circuit to which the meter is applied. Generally stated, portable volt-ohm-meters have higher resistivity on the higher voltage scales, while VTVM's, FET meters, and digital meters have the same input resistivity regardless of the range selected.

For example, suppose you wanted to read an AGC voltage of -8 volts, which was supplied through a 3.3

megohm resistor. A 1000-ohms-per-volt meter on the 10-volt scale would have a resistance of only 10,000 ohms. The 3.3M resistor and the meter resistivity form a voltage divider calculated like this: 10,000 divided by 3,310,000 (total of both) equals 3%, or a loss of 97% of the reading. **The pointer barely would move!**

Even a digital meter of 10-megohm input resistance would give some loss of reading. 10M divided by 13.3M (total of both) equals 75%, and 75% of -8 volts is -6 volts, an error of 25%. Although these are extreme examples, they show some of the possible errors.

### DC Voltage Analysis

It is most helpful to think of DC circuits as a collection of voltage dividers, whose parameters can be solved easily by the use of Ohm's Law.

We will analyze some examples taken from the simplified schematic of two audio stages shown in Figure 1.

Imagine that the plate/cathode DC resistance of V1 is a resistor. This resistor and R3 are the legs of a voltage divider from B+ to ground. From the voltages and values given, we can calculate the plate current (.65 milliamperere) and the DC plate resistance (about

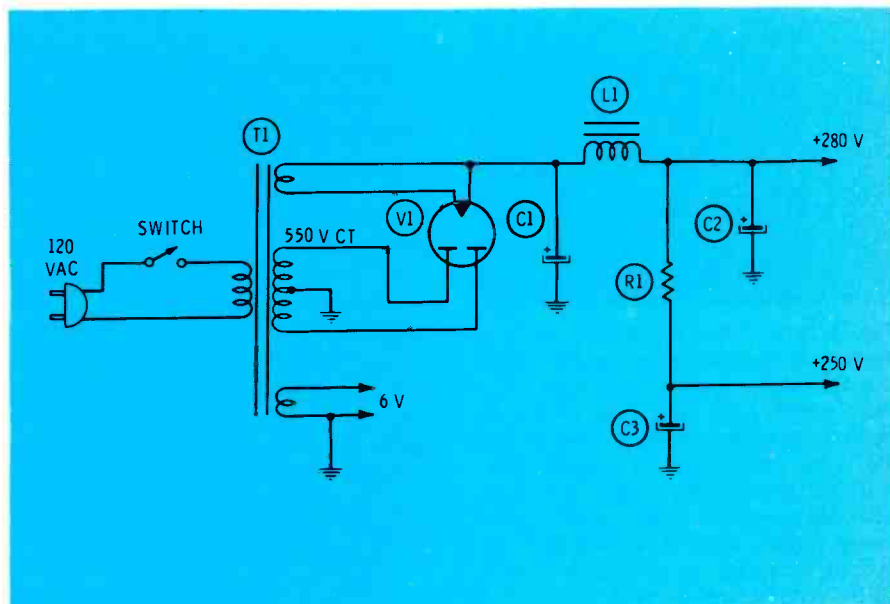


Fig. 2 This power supply for an older b-w TV receiver seems to be simple, yet defects can produce some hard-to-analyze symptoms.

140K) of the tube.

But suppose the plate of V1 measured +50 volts instead of the normal +90 (ignoring meter loading for the sake of clarity)? Other than any non-schematic paths such as circuit leakage because of dirt or flux, there are only three components which can affect the plate voltage. They are:

- V1 tube, whose plate current is determined by bias, condition, and plate voltage supply (assumed to be normal);
- C2, because leakage would apply voltage to R4 and the grid circuit of V2; and
- R3, whose value is half of the voltage divider.

Let's analyze. An increase in the

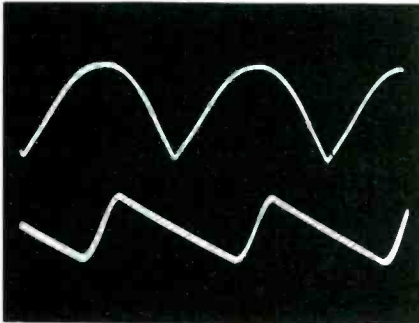


Fig. 3 Upper trace shows the 130-volt p-p 120-Hz parabolic waveforms obtained from a full-wave supply after all the filter capacitors were disconnected. Addition of an input capacitor increased the DC voltage nearly 50%, with sawteeth ripple waveforms of only 3 volts p-p.

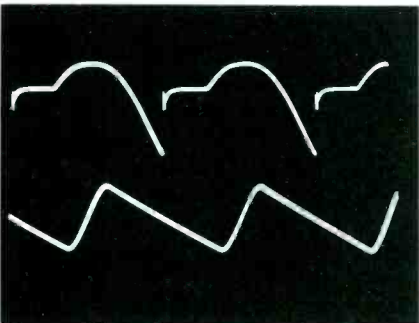


Fig. 4 Upper trace is the 120-volt p-p waveform obtained from a full wave supply with input filter open, but others following the filter choke of normal capacitance. For comparison, the lower trace shows the 3-volt sawteeth at the rectifier when all components were normal. Small sine waves were found superimposed on the DC voltage following the filter choke, but it was almost impossible to photograph them because of line-voltage bounce.

value of R3 would reduce the plate voltage by changing the value of one leg of the voltage divider (the plate/cathode path through the tube is the other leg). If the tube has been turned off long enough for the cathode to cool, an ohmmeter measurement across the resistor should be accurate. Another fast test would be to remove the tube from its socket, temporarily connecting a 150K resistor from the plate pin to ground, and measuring the voltage at the plate pin with the power on. If the voltage now is around +90 to +100, that would be proof the tube had been drawing too much plate current. If the voltage remains low, perhaps C2 is leaking.

What could cause V1 to draw excessive plate current? There's just one answer: the grid voltage is not sufficiently negative.

That brings up a more-difficult question. Why is the grid of V1 negative at all? There is no apparent source for the voltage. It's not because of the audio signal; the bias is there without input signals, also.

Notice the value of R2. Most grid resistors are 1M or less. This one is 10 megohm, and when the grid resistance is that high, some of the cloud of electrons around the cathode accidentally strike the grid, causing the negative voltage. The effect is called "contact potential", and the voltage is used for bias. Incidentally, such bias can be used correctly only with tubes that require a very-small bias voltage; often high- $\mu$  triodes are chosen by the designers.

Insufficient bias for V1 might be caused by a decrease in the value of R2 (not very likely), leakage in C1, or a gassy V1 tube.

If C2 were leaking, the grid of V2 would measure slightly positive (perhaps +1 to +4, or much more with the tube removed). For a sensitive test of C2 leakage, unsolder the end that goes to the grid of V2, then measure the DC voltage from the unsoldered end to ground. Any voltage in excess of (say) +5 indicates excessive leakage.

Because the grid is at zero voltage, bias for V2 normally is supplied by the voltage drop across the cathode resistor, R5. If this voltage is wrong, or if the grid is positive or negative, the bias is upset and the tube will draw a different plate

current, producing distorted sound.

Suppose the grid measured zero, but the cathode voltage was only +3 volts. There are three possibilities. R5 might have decreased in value, C3 could have internal leakage, or the tube V2 might be weak and drawing less plate current. The first step should be to see if the plate current had changed, and if so, how much. Because the same plate current flows in the cathode circuit as well (ignoring the screen-grid current), the current can be checked in both circuits by measuring the voltage drop across resistances there. Of course there is no discrete resistor in the plate circuit, but the primary winding of T1, the output transformer, has about 450 ohms. That's the reason the plate normally is about 25 volts lower in voltage than the supply. With a bias of only 3 volts, there should be **more** plate current if the defect is in the cathode circuit (larger voltage drop across T1). However, if the low cathode voltage is caused by a weak tube, the plate current should be lower than normal (less voltage across T1). An excessive plate current directs suspicion back to the components in the cathode circuit.

#### Power supply tests

Some power supply problems can be analyzed by Ohm's Law, but others cannot. Action of the filter capacitors is the reason.

The schematic in Figure 2 is a low-voltage power supply typical of those in older tube-type b-w TV receivers.

Most power supplies provide AC for the tube heaters, and filtered DC voltages for the plate supplies of the tubes. In this case, the heaters are supplied from a 6.3 volt AC RMS winding of T1, while V1 is a full-wave rectifier tube (perhaps a 5U4G) whose filaments are operated from a 5-volt winding, and with the plates supplied by voltages (180° out-of-phase) from the center-tapped secondary. When a rectifier plate is more positive than the filament, current flows through the tube to the filter capacitors and the load. Therefore, current flows alternately through the two plates. This is full-wave rectification which produces a ripple (hum) frequency of 120 Hz.

A full explanation of the rectification action is beyond the scope of this particular article, but we will



give some of the information most needed for troubleshooting.

Without any filter capacitors, the output at the filament of the rectifier tube would be a series of parabolic pulses of 120 Hz frequency (top trace of Figure 3). Addition of C1 changes the large parabolas to small sawteeth by storing the voltage and allowing only a slight drop between pulses (Figure 3, bottom trace). This increases the average DC voltage substantially.

It might surprise you to know that only the value of the input capacitor (C1) of the three shown has any large effect on the DC voltage. An open C1 not only reduces the DC voltage and increases the amount of ripple, but it also changes the circuit into a choke-input type which gives a very peculiar waveform at the rectifier tube (see Figure 4, top trace).

DC voltage decreases approximately 20% when C1 is open. An open C2 or C3 might allow some undesired sweep or video waveforms to appear at those points, but the DC voltage would be unchanged.

Remember these six factors that determine the DC voltage obtained

from rectifier circuits:

- exact amplitude and waveshape of the input voltage;
- whether the circuit is a capacitor-input or choke-input type;
- whether the circuit is a half-wave or full-wave type;
- value of the input capacitor;
- condition of the rectifier (or rectifiers) and the value of any resistances in the circuit; and
- current drain of the loads connected to the supply (this also includes filter-capacitor leakage).

If the DC voltage is too low, test for all six of these conditions, **they are the only ones that affect the DC voltage.**

Theoretically, a half-wave circuit could have the same DC voltage as a full-wave one, by merely using a much-larger input capacitor. In practice, they seldom do.

A diode bridge rectifier is a full-wave circuit, and if just one of the diodes opens, the DC voltage decreases about 5% to 10%.

Many power supplies in television receivers have about the same output DC voltage as the RMS value of the input sine-wave.

The absolute limit of output volt-

age is reached with a very-large input capacitor and no load. Under those conditions, the DC voltage is 1.414 times the RMS value of the input sine wave.

As you can see, a simple power supply can clout you with some mystifying symptoms which require a thorough knowledge of both theory and practice to solve them.

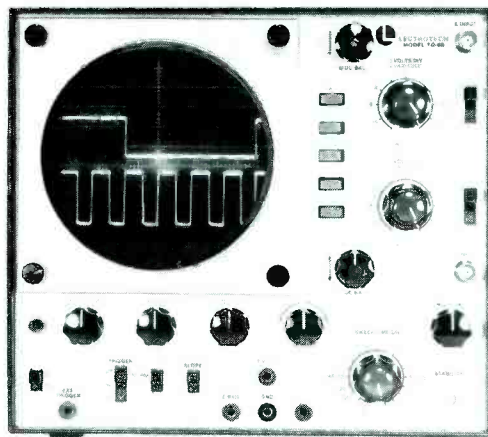
### Summary

For efficient repairing of complex TV sets, a technician needs:

- a thorough knowledge of how the circuits are supposed to work;
- an equally-thorough knowledge of what symptoms result from the failure of **each** part in **each** circuit;
- a logical system of troubleshooting that steers him to the heart of the trouble in the shortest period of time;
- accurate and dependable test equipment; and
- complete and accurate service data for the models serviced.

Few examples could be given here because of space limitations. If you don't understand certain TV circuits, write to the editor with your suggestions. □

## the new automatic . . .

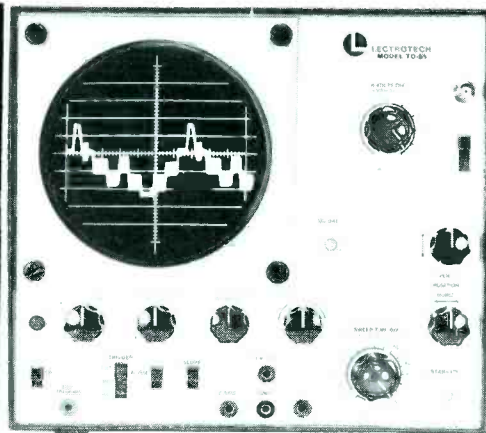


TO-60 dual-trace

TO-60 automatic dual-trace triggered sweep oscilloscope  
 Bandwidth: DC 15 MHz  
 10 mV sensitivity **\$489.50**

TO-55 automatic single-trace triggered sweep oscilloscope  
 Bandwidth: DC 10 MHz  
 10 mV sensitivity **\$379.50**

Made in U.S.A.



TO-55 single-trace

Two outstanding new five inch oscilloscopes with exceptional stability, featuring:

- Automatic Triggering ● Automatic Astigmatism ● Automatic Horizontal Sweep ● Automatic TV Trigger Selection ● All Switching 1-2-5 Sequence ● Vertical Amplifier Sensitivity: .01 volts/div. ● Horizontal Sweep Speed .2 Sec.-.5  $\mu$  Sec./div. ● 5x Magnifier ● All Solid State ● TO-60 Dual Trace Capability: Channel "A", Channel "B", A-B Chopped, A-B Alternate, Sum of A & B.



See your distributor or write:

**LECTROTECH, INC.**

5810 N. Western Avenue, Chicago, Illinois 60659 (312) 769-6262



Available in Canada from Superior Electronics Inc.

For More Details Circle (11) on Reply Card

# Reports from the test lab

*These monthly reports about electronic test equipment are based on actual examination and operation in the ELECTRONIC SERVICING laboratory. Observations about the performance, and details of new and useful features are spotlighted, along with tips about how to use the instruments for best results.*



By Carl Babcoke

Every electronic service shop needs a good scope. That's a trite, but very true, statement. A new



Telequipment D61 triggered-sweep, dual-trace, light-weight, wide-band scope that is available from Tektronix.

generation of triggered-sweep scopes with unique features and superior performance makes this an excellent time for you to upgrade this item of test equipment. We will be reporting on other models in the near future.

This month the Telequipment Model D61 scope by Tektronix is spotlighted. The strong points of this model are the unusual sharpness and brilliance of the waveforms, and the simplified controls.

## General Description

In brief, these are the basic specifications of the Telequipment D61 scope:

- 5" CRT with 8X10 centimeter markings, and a 3.5 KV anode voltage for increased brightness and sharpness;
- all solid state (except CRT) for stability and less drift;
- high-gain vertical (.01 V per CM) and wide band (10 MHz);
- triggered sweep with only one locking control plus auto switch;
- operates in single-beam, dual-trace, X-Y, and vector modes;
- small (6.3 inches wide) and light (15 pounds); and
- has few controls for simplified operation.

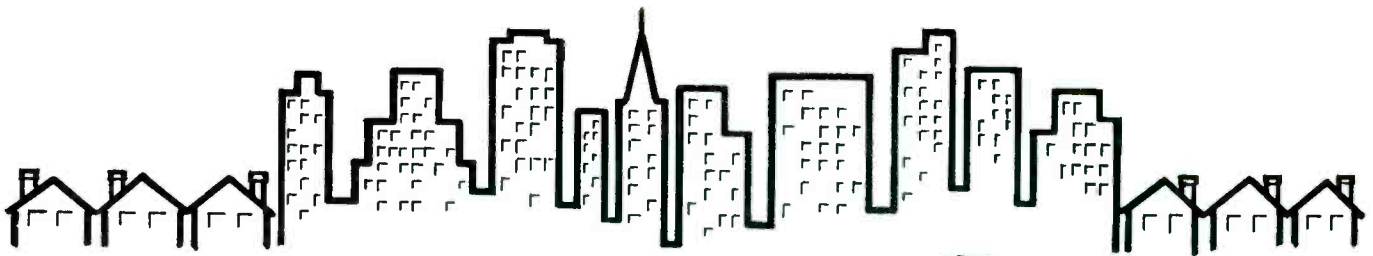
## Vertical Amplifiers

There are two identical vertical amplifiers for the dual-trace and X-Y functions. Gain is determined by a Volts/Division switch in each channel. No calibration adjustments are provided on the outside, and none are needed; gain is very stable. Nine voltage range positions are provided, from 5 volts p-p per division to .01 volts p-p per division. No variable gain control is provided. The 5, 2, and 1 sequence of the range switch limits the steps of gain to no more than 2-1/2 times, making a variable control unnecessary. This also prevents errors of voltage reading that might arise if you forgot to return a control to the calibrate position.

Concentric with the gain switches are the vertical centering controls for each channel. To eliminate a channel, merely turn the knob fully counterclockwise until a switch clicks. For dual-trace operation, both should be turned to about the mid rotation, then adjusted for the desired relative positions of the waveforms on the screen.

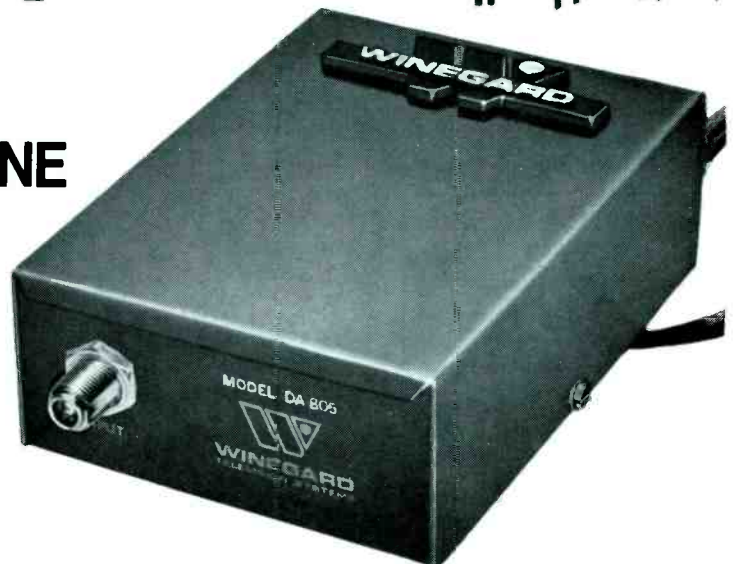
Each channel also has a slide switch to select AC or DC coupling to the vertical amplifiers. The internal amplifiers are all DC coupled; the switch adds or takes away a





# Announcing the WINEGARD METRO-LINE TV-FM DISTRIBUTION AMPLIFIERS

...the first high input,  
high output, low-cost  
MATV system amplifiers  
for strong signal areas



Winegard's new Metro-Line amplifiers are specifically engineered to accommodate strong signals and eliminate overload economically and efficiently. Because they have the same commercial quality construction and circuitry as the DA-830, DA-825B and DA-815, they are ideal for home, hotel, apartment and office building systems.

Check these other important performance features:

- High output capability makes a Metro-Line your best db buy
- High input solves distortion and overload problems common in strong signal areas
- Lightning protection diode
- 82 channel models have separate VHF and UHF amplifier stages
- Extended band pass (54 to 300MHz) includes mid and super band coverage making Metro-Line approved for CATV use
- Eliminates multiple outlet charge for extra sets or MATV systems on cable TV
- UL listed
- Easy for any competent TV service dealer to install
- Choose from 3 VHF-FM and 2 VHF-UHF-FM models; suggested list prices from \$30.85 to \$47.30

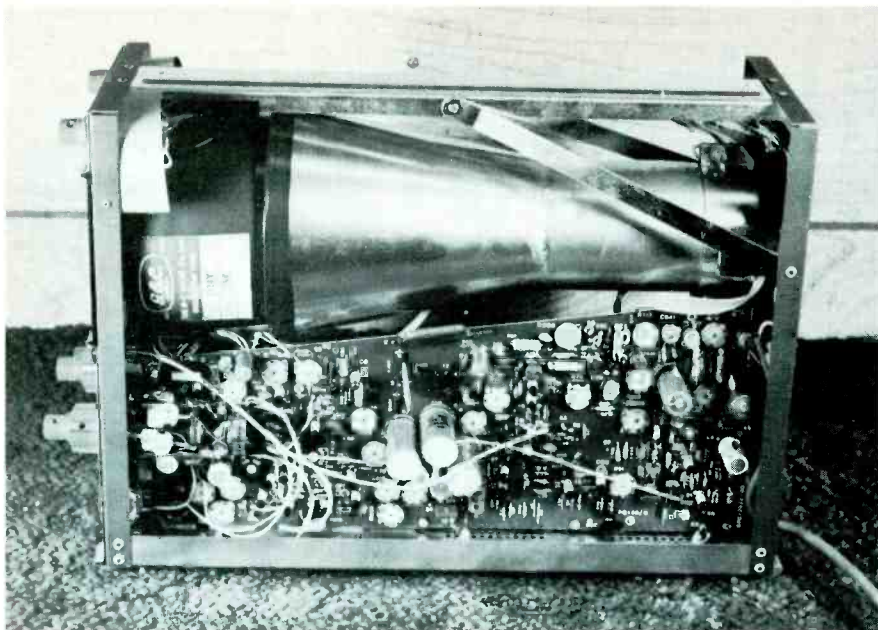
		DA-203	DA-205	DA-215	DA-803	DA-805
OUTPUT PER CHANNEL*	VHF	46dbmv	46dbmv	53dbmv	43dbmv	45dbmv
	UHF	NA	NA	NA	35dbmv	35dbmv
INPUT PER CHANNEL*	VHF	31dbmv	31dbmv	40dbmv	31dbmv	31dbmv
	UHF	NA	NA	NA	26dbmv	26dbmv
GAIN	VHF	15db	15db	13db	12db	14db
	UHF	NA	NA	NA	9db	9db
IMPEDANCE		300 ohm	75 ohm	75 ohm	300 ohm	75 ohm
Bandpass	VHF	54 to 300MHz	54 to 300MHz	54 to 300MHz	54 to 300MHz	54 to 300MHz
	UHF	NA	NA	NA	470 to 810MHz	470 to 810MHz
NOISE FIGURE	VHF	4.2db	3.3db	4.8db	4.3 db	3.3db
	UHF	NA	NA	NA	10.0db	7.3db
POWER REQUIREMENTS		117VAC, 60Hz, 2.3 watts	117VAC, 60Hz, 2.3 watts	117VAC, 60Hz, 2.3 watts	117VAC, 60Hz, 3.5 watts	117VAC, 60Hz, 3.5 watts

\*7 channels VHF, 5 channels UHF      0.5% Cross Modulation

For additional information and sample system layouts, request New Product Bulletin No. 24.



**WINEGARD TELEVISION SYSTEMS**  
Winegard Company / 3000 Kirkwood Street  
Burlington, Iowa 52601

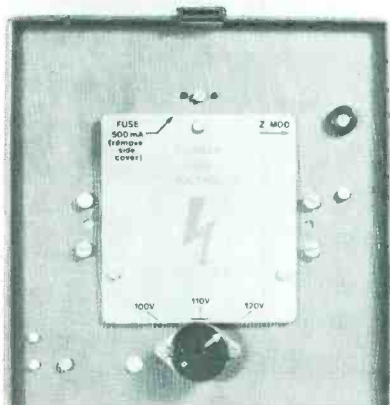


One circuit board holds the small components. Removal of only two screws frees the carrying strap and both side panels.

coupling capacitor in series with the signal from the input connector.

A third position of the slide switch (marked "ground") often is useful. In this position, the probe is disconnected, and the amplifier input is grounded to provide a zero reference without the bother and wasted time otherwise necessary to disconnect the probe from the circuit under test and ground it to the scope.

Although our test machine had "banana"-type input plugs, which necessitated a BNC-to-banana adapter for each channel, we are informed that later production runs will have BNC jacks, giving better freedom from pickup of hum or RF.



"Z Mod" input jack and the line-voltage switch are located on the rear of the cabinet.

#### How dual-trace is obtained

The CRT is a single-beam type with only one set of deflection plates, and two waveforms are displayed by one of two modes of **time sharing**. Persistence effects of both the eye and the CRT phosphor combine to give the illusion of two separate and complete waveforms.

At slow trace speeds, the "chop" mode shows less disturbance on the screen. Waveforms of the two channels are displayed by alternating small bits at a 100KHz rate.

Best results at fast sweep speeds are obtained by showing the waveform of one channel for one entire sweep, then the other channel signal for one sweep, etc. That's called "alternate" mode.

In the Telequipment D61, chopping is switched on internally for the Time/Division ranges of 500 milliseconds to 2 milliseconds inclusive plus "Ext X", and the alternate mode is selected automatically for ranges of 1 millisecond to .5 microsecond inclusive. I have not found any occasions to wish the mode could be selected manually.

#### Horizontal Sweep And Amplifiers

Nineteen positions of the "time/division" switch select the amount of time required to sweep horizontally each of the one-centimeter graticule divisions. No variable control is provided; the concentric con-

trol adjusts the horizontal centering, and pulling out on the knob expands the horizontal sweep width by a factor of X5.

Briefly stated, the horizontal sweep in recurrent-type scopes runs at a steady rate whether locked or not, and its frequency is equal to or less than the repetitive rate of the waveform under observation. **The key word is "frequency"**.

Triggered-sweep scopes generally do not have horizontal sweep without an input signal to which it is "locked". A certain voltage and polarity (selected by the locking knobs) triggers the horizontal sweep, which deflects completely across the screen in a precise length of time (selected by the Time/Division switch). Then the sweep stops and waits until triggered again by the next similar voltage and polarity from the sync circuit. That's why the brightness of some waveforms is dim; the sweep is operating for a much smaller period of time than it is off. **The key word with triggered sweep is "time"**.

The D61 has an "auto" switch, which when activated by pulling out on the "trigger-level" knob, permits a base line sweep, even when there is no signal in the vertical amplifier to trigger it.

Below the trigger-level knob is a sliding switch marked "Ext/Ch1/Ch2", and the setting of this switch determines the source of the triggering signal. When using the "Ext" position, you should use a test lead to connect the external-sync signal to the "Trig/Ext X" banana jack located just below the switch. (This same jack is used for external sources of horizontal sweep, when the "time/division" switch is set to "Ext X" position.)

There are two other sliding switches. One is marked "+ and -", and it selects the polarity of triggering signal which gives best locking. The "AC" position of the "AC/TV" switch is for locking to waveforms other than composite video, while the "TV" position switches in an internal sync separator to give clean sync from video. Incidentally, the proper vertical or horizontal sync is selected automatically according to the setting of the "Time/Division" switch.

The two sweep times most often used for TV servicing are: 5 milliseconds for vertical field rate, producing slightly less than 3 fields;



and 20 microseconds for horizontal rate, which gives about 3 cycles.

### Calibration Aids

On the right, just under the CRT, is located the "Probe Test" jack. Signal at this jack is about 2.5 volts of the horizontal sweep square wave, which appears on the screen (when a probe is connected to the jack) as a right angle, as shown in Figure 1. Adjustment of the compensation in the probe changes the angle from rounding to overshoot. A sharp corner is the correct waveform.

The jack on the left has a .5 volt p-p square-wave 60-Hz signal, useful for checking the accuracy of the vertical amplifier gain.

### CRT Controls

At the top of the front panel are

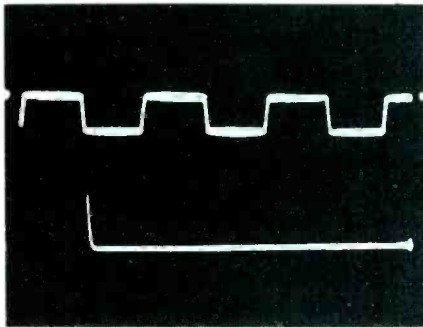


Fig. 1 Trace at the top is the 60-Hz .5 volt p-p gain-calibration waveform available at the "Cal" jack. The right-angle waveform at the bottom is the sweep square wave used to check or compensate the bandwidth of the X10 probes. To make it more clear, the trace has been moved to the right. Sweep of about 5 mS or 2 mS seems to work best. Adjust the trimmer in the probe for the sharpest corner without overshoot.

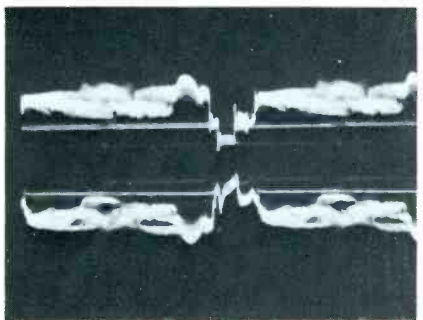


Fig. 2 Triggered sweep with the internal sync separator gives steady video waveforms, and dual trace permits a comparison of the wave-shapes from two points. This is a very effective way of isolating intermittents. Sweep time was 10  $\mu$ S and X1.

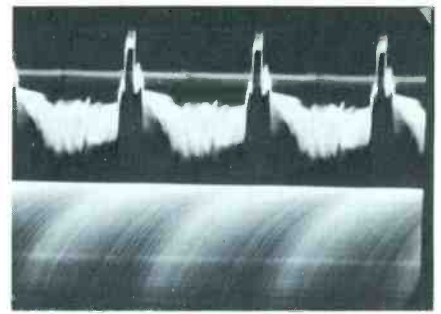
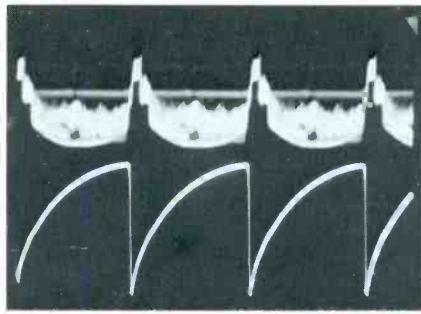


Fig. 3 The true phase relationship shown by dual trace makes possible an easy and accurate way of proving correct horizontal locking. Picture at the left shows the video (at horizontal rate) and sawteeth from the horizontal oscillator. The same number of cycles proves the oscillator is locked. When the horizontal is out of lock (right), the sawteeth move sideways in a blur of movement. Sweep was 20  $\mu$ S and X1.

the CRT controls. "Intensity" adjusts the brightness and "Focus" determines the sharpness of the waveforms. As with all scopes, best focus is obtained when the brightness is operated below maximum, in this sample at about halfway on the control.

### Probes

Either X1 or X10 probes can be obtained for the D61. For TV work, I recommend X10 probes, because the capacitance loading is less and even .1 volt produces a height of 1 centimeter.

Also available is an AC-current clamp-on probe for taking the waveform without breaking the circuit. This is an interesting application to be described later.

### Waveforms

The proof of scope quality is in the waveforms it produces, and the following waveform pictures should furnish that proof, in addition to providing you with some ideas for dual-trace operation.

#### Video waveforms

In TV servicing, video waveforms probably rate highest in importance, followed closely by sync and sweep waveforms.

A combination of built-in sync separation and triggered sweep provided rock-steady video waveforms on the D61 (something that's difficult or impossible with some scopes).

Dual-trace operation makes video waveforms even more valuable. For example, showing the video from two stages at one time (Figure 2) makes any differences, such as compression, loss of bandwidth, or

amplitude of burst, much easier to spot.

Also by checking input and output signals of one stage simultaneously, you can track down intermittents in a hurry.

#### Checking sweep frequencies

It's a frustrating experience to waste too much time checking for

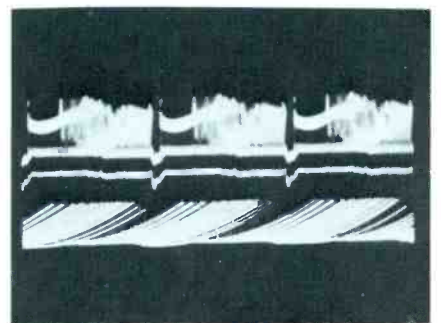
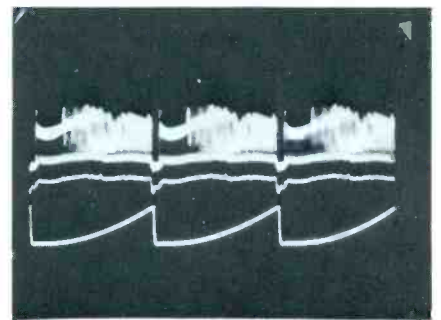
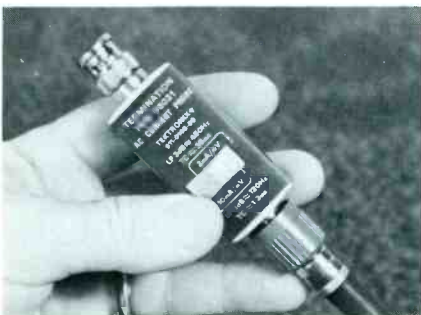
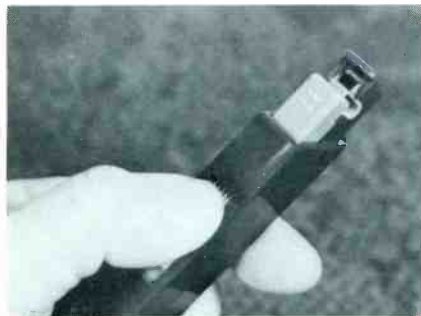
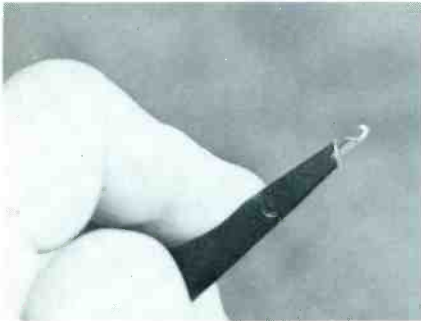


Fig. 4 Vertical locking can be checked in the same way. Lock the scope to the video on Channel 1 with the internal sync separator and 10 millisecond sweep, and any vertical waveform on Channel 2 (top picture). Movement of the sweep proves the vertical is rolling; one sweep cycle to two of video proves the vertical is running at 30 Hz; or two sweep cycles to every one of video means 120 Hz operation. Other ratios are possible; to solve them a slower sweep of 20 mS is helpful.

loss of high voltage only to find eventually that the horizontal oscillator was miles out of frequency. One easy way to determine when the horizontal oscillator is locked to the station (and therefore on correct frequency) is to look at the video and the output of the oscillator together. If you can adjust the locking of the set so there is one horizontal TV field to every oscillator sawtooth (Figure 3A), it is proof of correct frequency. Tip: if the oscillator is away out of frequency, it might be necessary to use



The top picture shows the end of an X10 Tektronix probe with the housing retracted to expose the hook used to grasp wires or connections. In the center is the P6021 clamp-on AC-current probe with the slide partially retracted to show the slot for the current-carrying wire. After a wire is inserted, the magnetic material of the slide completes the transformer core, and a separate winding feeds the induced voltage to the termination adapter. The termination (Tektronix number 011-0105-00 in bottom photo) has a two-position switch for high or low sensitivity.

an external bias pack on the AGC to prevent overload. Adjust the bias for good video amplitude without clipping.

On the other hand, if you have locked to the video waveform and find the oscillator signal moving rapidly across the screen of the scope (Figure 3B), it's certain the oscillator is not operating at the right frequency.

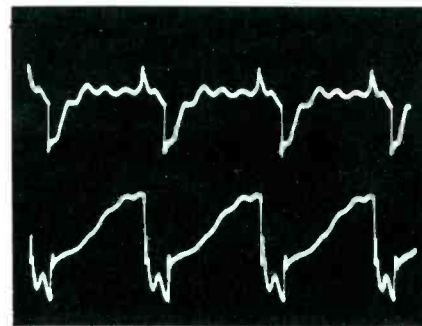
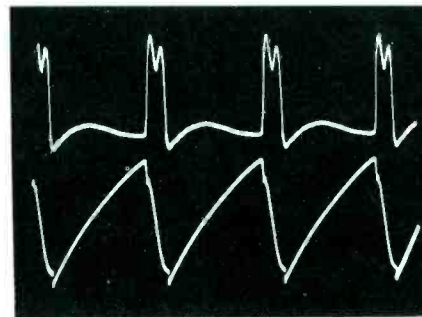
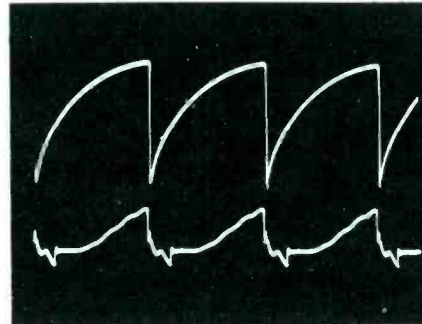


Fig. 5 The Tektronix clamp-on current probe provides current waveforms in the horizontal sweep circuit without opening the circuits. Top picture shows the smooth sawteeth of the oscillator and the near-sawteeth of the plate current of the horizontal output tube (probe around the plate lead). Center photo contrasts the HV pulses with the sawteeth of yoke current. Some distortion appears because of mismatch from use of a test jig. Bottom picture top trace is the damper tube current (negative going) and the output tube current (bottom trace) which together make up the sawteeth of yoke current. All waveforms at 20  $\mu$ S sweep with external locking from HV pulses to maintain the same phase relationship.

Vertical frequency and locking can be determined the same way, although the vertical field frequency of the scope must be used. Lock the scope's Channel 1 to the video, then use a vertical-sweep waveform on Channel 2, as shown in Figure 4.

#### Checking horizontal-sweep current

It's always been a lot of trouble to measure the current in horizontal-sweep circuits, yet such information is often very helpful.

Tektronix (the importers of Telequipment scopes) has an AC current probe that doesn't require breaking the circuit (see photo). With it you easily can check the p-p current and waveform of the horizontal output tube (or transistor), damper tube or diode, and the horizontal yoke coils. A collection of such waveforms, combined with the usual horizontal oscillator and HV pulses can help us understand the operation of horizontal sweep (Figure 5), as well as point to the origin of defects in the circuit. Unfortunately, the low-frequency response of the probe doesn't give true waveforms of vertical-sweep current.

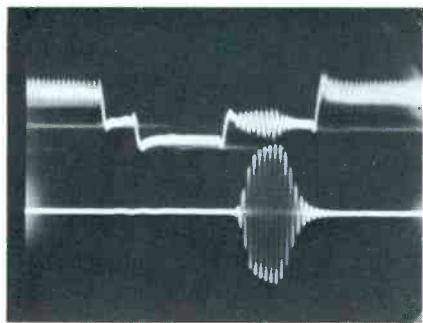
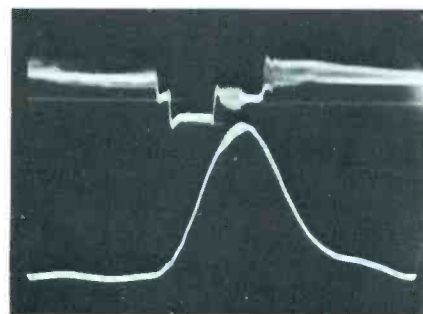
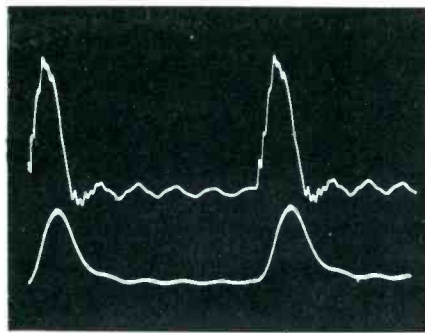
#### Chroma waveforms

Burst keying requires that the enabling horizontal pulses be delayed in time (lagging phase) so they reach the keyer at the same time as the burst. Figure 6A shows a phase comparison between the raw horizontal pulses and the pulses delayed by traveling through a low-pass filter of 100K and 120 pf.

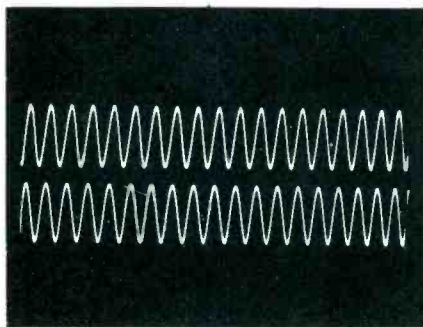
The expanded waveform of Figure 6B clearly shows that the pulse has been delayed too much, although the burst separator did operate okay. Another way of determining the phase of burst and pulses is to compare the burst in the video to the output of the burst separator (Figure 6C). This also shows any spurious ringing that might masquerade as burst.

Phasing of the color demodulators can be checked approximately by dual-trace waveforms of the 3.58 MHz carriers that are applied to the demodulators. At .5 microsecond (shortest sweep time on the D61), about 19 sine waves can be counted (Figure 7A), and that's too many to show relative phase. But by switching to X5 (Figure 7B), it's easy to see the phase of the sine waves (slightly more than 90°).

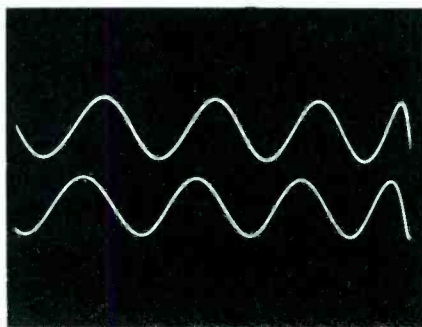




**Fig. 6** Dual trace shows the delayed phase of the pulses at the burst keyer. Top picture top trace displays the raw pulses from the flyback, and the bottom trace is the pulses after being delayed by a RC low-pass filter ( $10\ \mu\text{S}$ , X1). Video waveform and the waveform at the grid of a burst keyer are shown in the center picture. The pulse has been delayed too much, but not enough to stop the keying of burst ( $20\ \mu\text{S}$ , X5). In the bottom photo, the excessive delay results in a narrower burst at the output of the burst keyer ( $10\ \mu\text{S}$ , X5).



**Fig. 7** The shortest sweep time ( $.5\ \mu\text{S}$ ) gives about 19 cycles of 3.58 MHz sine waves. However, by using the X5 switch, the width is increased enough to show the phase relationship between the carriers applied to the two color demodulators. Brightness is reduced because of the width.



Color bar patterns at the picture tube are convenient to analyze in the dual-trace mode, because both R-Y and B-Y can be displayed at the same time. Figure 8 shows the red, blue, and green color bar signals at the cathodes of the picture tube in a new 19" Quasar solid-state color set.

With the D61, vector "petal" patterns are very easy to obtain, because of the identical vertical channels. Set the Time/Division knob to the "Ch 2" position, connect the probe of Channel 1 to the R-Y signal, the probe of Channel 2 to the B-Y waveform, and then adjust the Volts/Division switches of both channels to the same range, the one giving a nearly full-screen display (see Figure 9).

#### VITS analysis

With practice, you can learn to interpret the Vertical Interval Test Signals (VITS) which are transmitted on network shows in the vertical blanking area at the top of the picture. The most significant portion of these test signals to TV technicians is the multi-burst section. A receiver with perfect response up to 4 MHz would show all the bursts at the same amplitude. No modern color set has such a wide bandwidth, so it's necessary to view the VITS on many sets, and average the results before you can arrive at a standard.

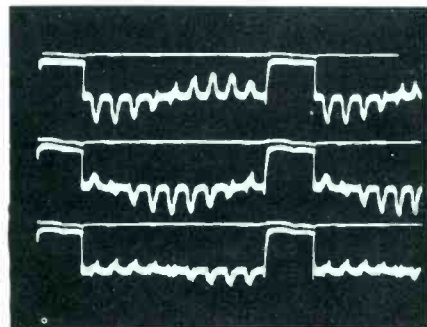
Single-trace scopes with triggered sweep will display the VITS, but both fields will overlap, making analysis more difficult.

#### Summary

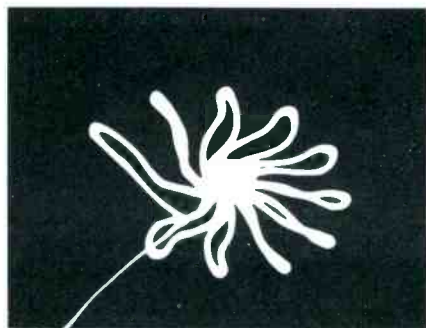
The Telequipment D61 scope perfectly performed the types of waveform measurements normally expected of scopes used for servicing

TV receivers. In these tests, we operate the test equipment much as you would in your own shop.

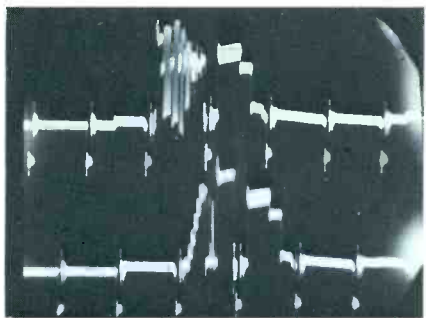
Especially impressive were the extra-bright waveforms, and the internal automatic circuits which eliminate many of the front panel adjustments. □



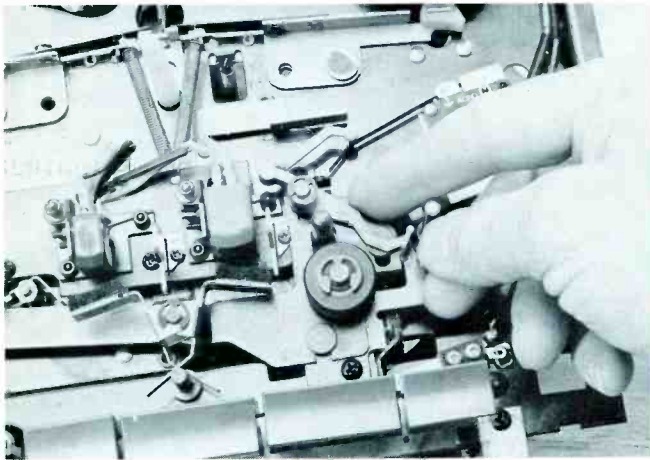
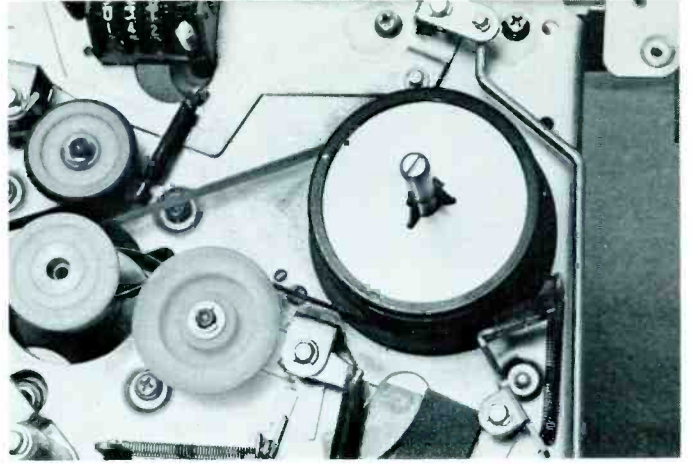
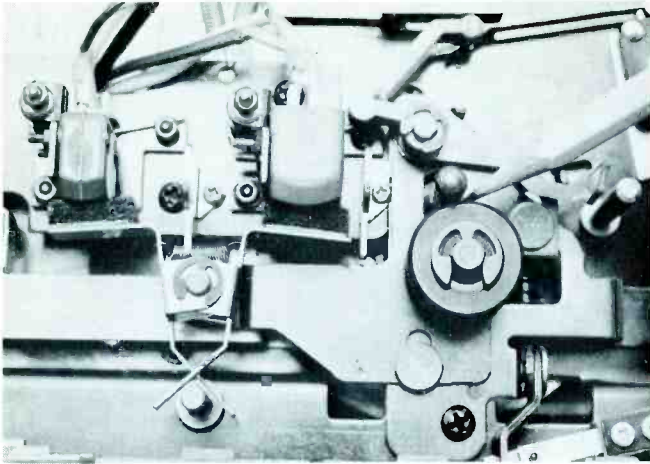
**Fig. 8** Any two color bar signals at the picture tube can be viewed at the same time. Here, a combination of dual-trace and double exposure in the camera shows all three. Top trace is red cathode, center is blue cathode, and bottom is green cathode of the picture tube in a new 1975 model Quasar.



**Fig. 9** On the Telequipment D61, vector "petal" patterns are very easy to obtain because of the two identical vertical channels. See the text for details.



**Fig. 10** Top trace is the VITS of the first vertical field, bottom is the second field. Not all VITS waveforms are alike, but you can analyze them with practice. Sweep was 200 microseconds and X5, with locking aided by the internal sync separator.

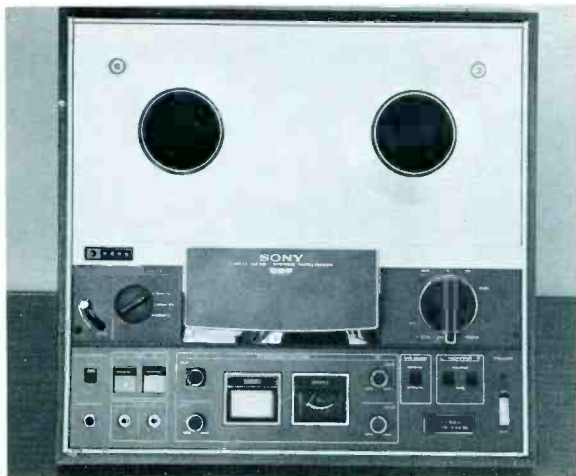


Step 1. Hi-fi tape recorders have three major operations: Play, Fast Forward, and Rewind (Recording is merely an extension of Play). Several assemblies go to work when you push the Play button. (1) The pinch roller moves in against the capstan, to pull the tape along. (2) The brake pads pull back, releasing the supply and takeup spindles. (3) The automatic shutoff mechanism comes in against the tape. (4) A lever presses on the takeup clutch assembly, letting that spindle try to turn slightly faster than the tape is fed. On the machine pictured, belts drive the flywheel and the takeup spindle.

Forest H. Belt's

# WORKSHOP ON HI-FI TAPE RECORDERS part 3

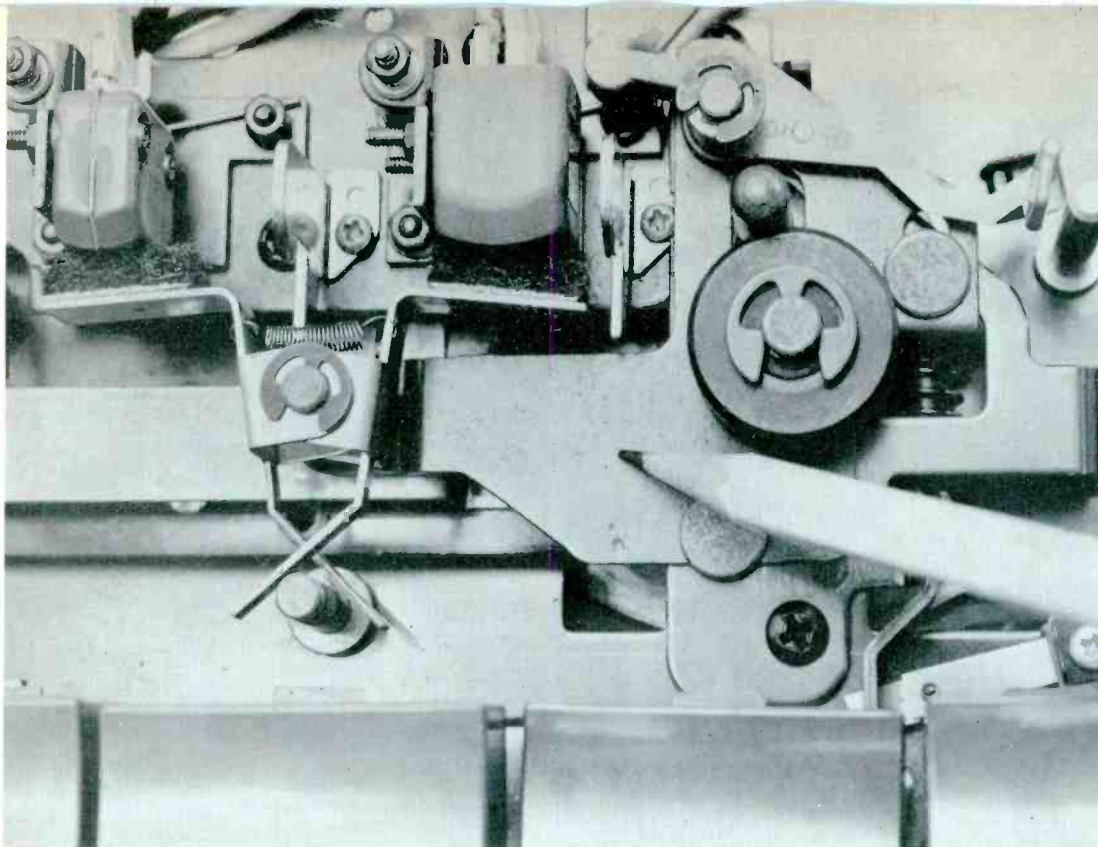
By Dewey C. Couch



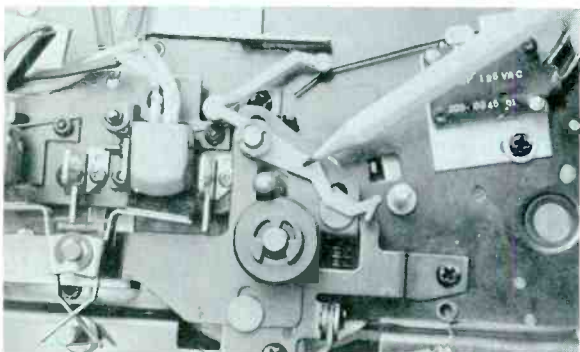
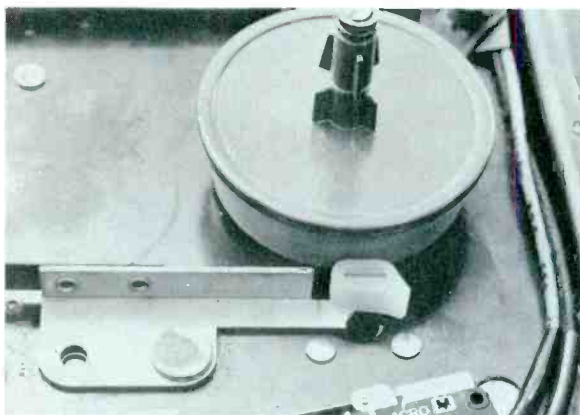
*In the first two sessions of this Hi-Fi Tape Recorder Workshop, you saw how to clean, test, and adjust typical mechanisms. All you need to round out this knowledge is a tour through the inside of a couple of typical machines. Then, you should be able to go about tape recorder servicing with confidence. What you've learned so far, and the points you pick up in this session, acquaint you with just about any tape recorder you're likely to encounter. You can adapt those procedures to virtually any brand or model.*

*The two most basic tape recorder mechanisms are **push-button** and **selector-cam**. This refers to how the functions are initiated. There are variations. But learn how these two work, and you have the fundamentals necessary to figure out the secrets of any other. Let's take the pushbutton version first.*

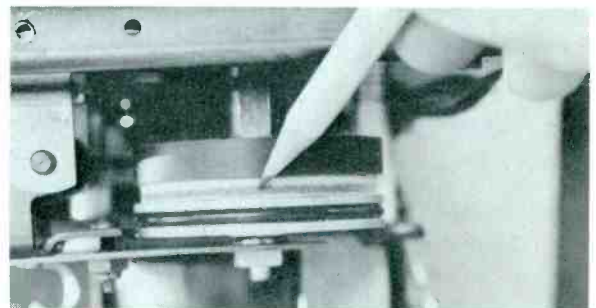
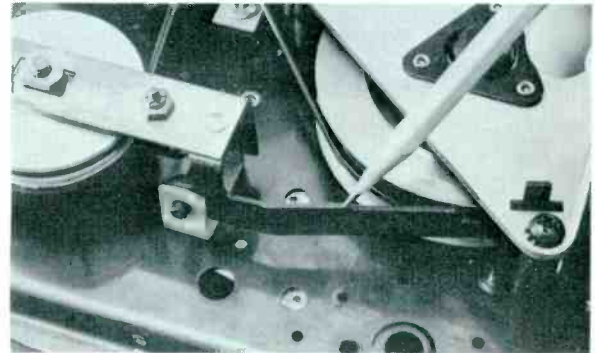




**Step 2.** A short linkage, connected to the play-button slide, carries the pinch-roller plate forward. A spring presses the pinch roller against the capstan. You can see the spring and plate in the photo. Two pressure pad assemblies, mounted on the same plate, also move forward to press the tape against the heads.

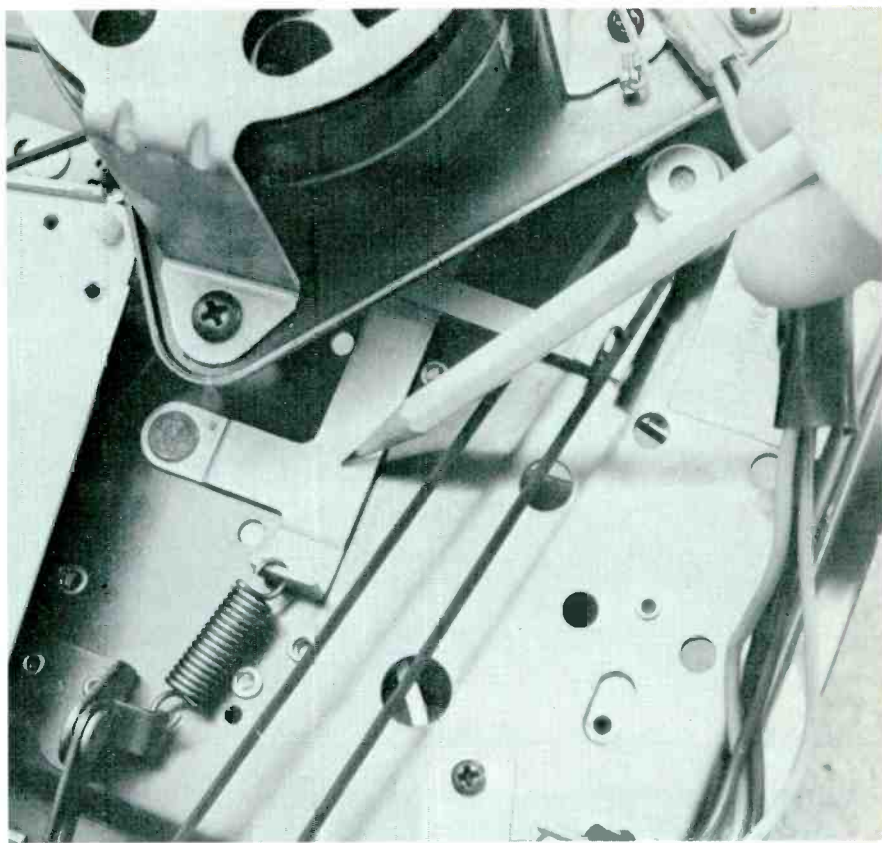
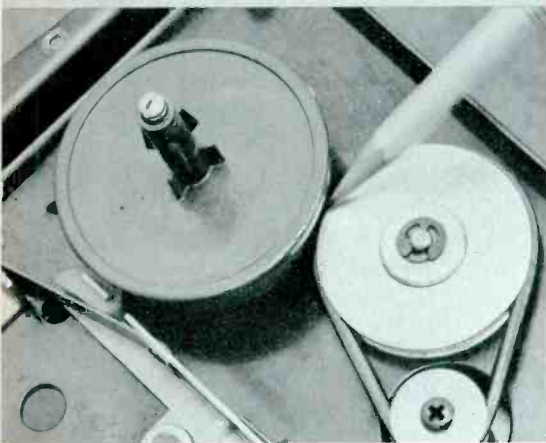


**Step 3.** Another linkage releases a slide below the base plate, allowing a spring to pull it forward. The slide has two functions: It pivots the brake levers and moves the shoes back from the spindles. It also releases the automatic shutoff arm. The tip of that arm, pivoted by a spring, moves across the path of the tape. If there's no tape or if the tape has too much slack, the arm actuates a power microswitch, turning off the motor.

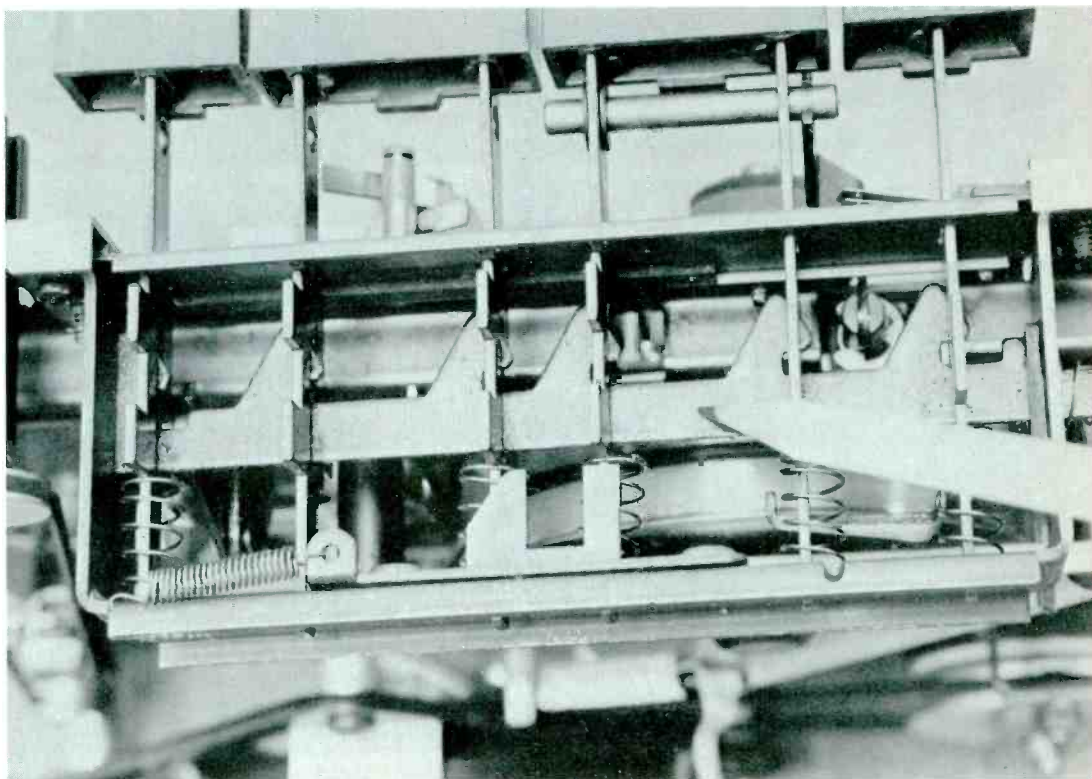


**Step 4.** An offset step near the bottom of the Play-button slide pivots a large lever, also below deck. The end of the lever away from the slide pivots upward, applying pressure to the takeup clutch assembly. The clutch assembly comprises a "sandwich" that consists of a belt-driven pulley, a felt pad glued to the pulley, and a drum that is part of the takeup spindle shaft. When the lever presses on the pulley, the pad's friction holds the whole assembly together, causing the takeup spindle to turn with the motor and belt. The pressure applied by the lever can be varied (explained earlier, in session 2). When you push Fast Forward, that slide pivots the same lever, only further, applying greater pressure to the takeup clutch.

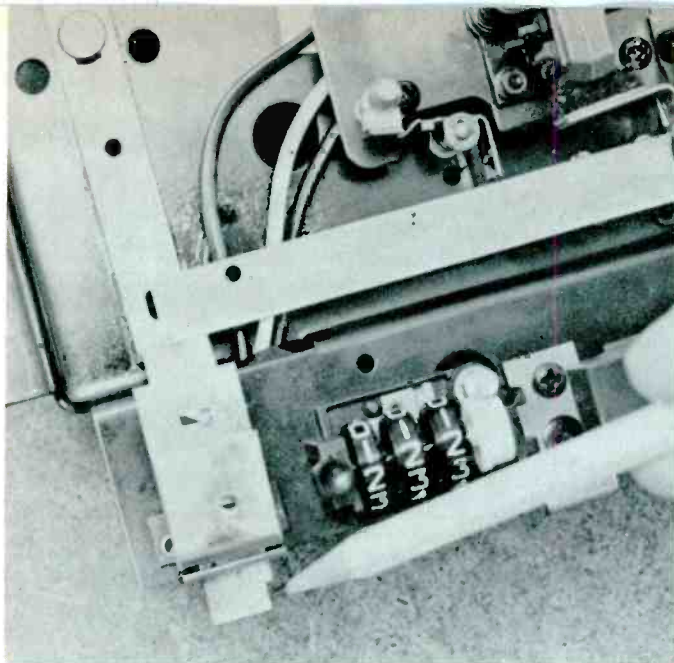
**Step 5.** The Rewind-button slide connects to a linkage which pulls on a spring when you push the button down. The spring pivots an L-shaped lever, the other end of which moves the belt-driven rewind idler to the left. The rubber belt on the idler presses tightly against the supply (rewind) spindle. The spindle spins rapidly in a direction opposite to the way the motor turns.



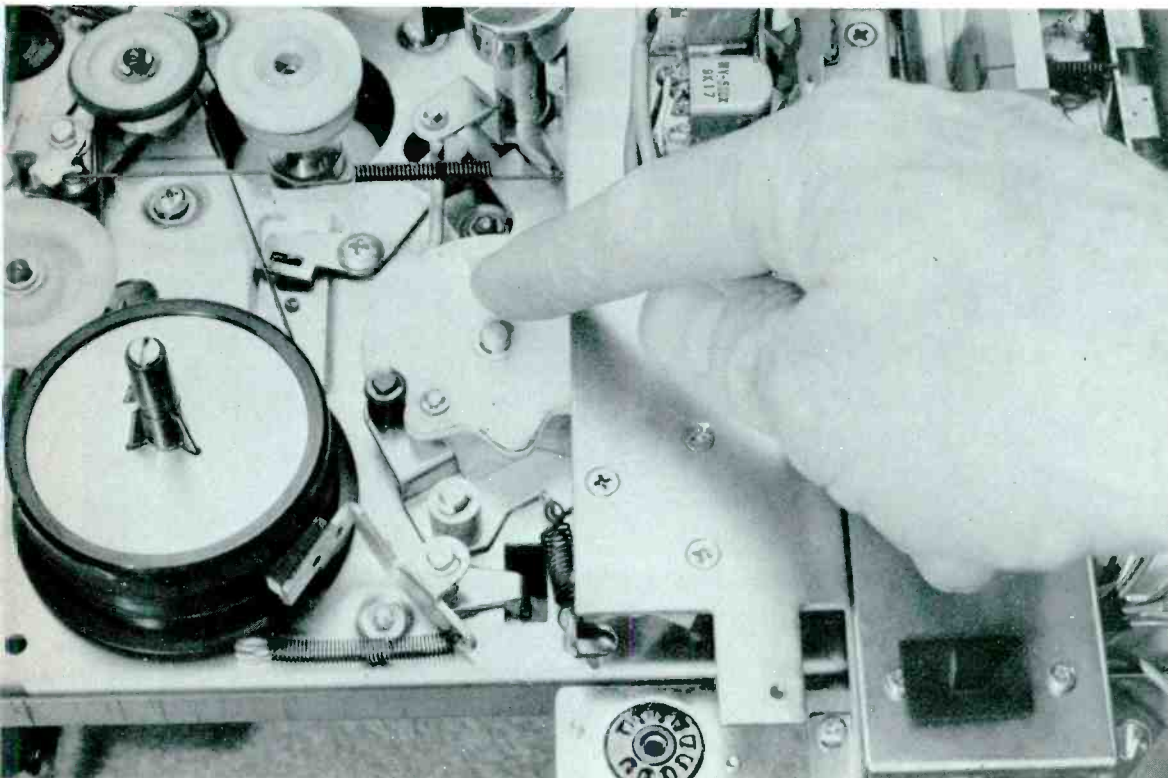
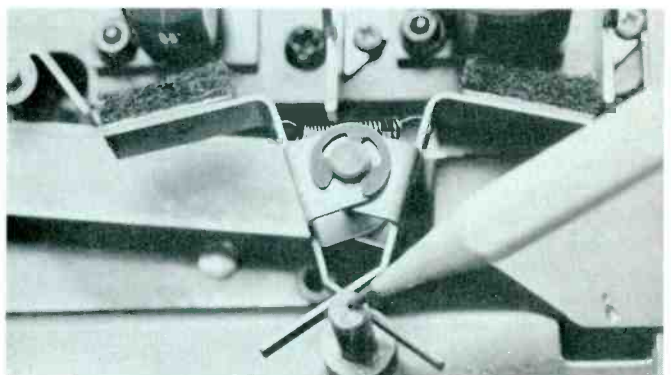
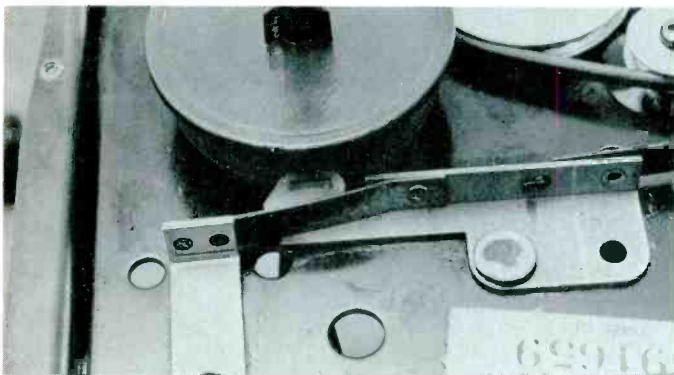
**Step 6.** The Stop button operates simply. The stop-button slide shoves a latching plate to the left, releasing any button that might be depressed. Various connecting springs and links return the mechanism to "Stop."







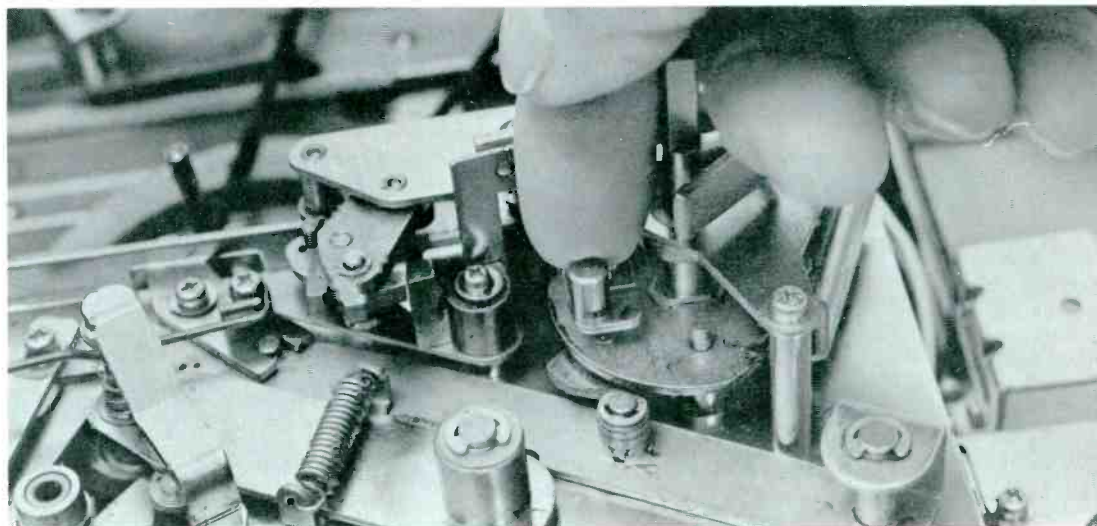
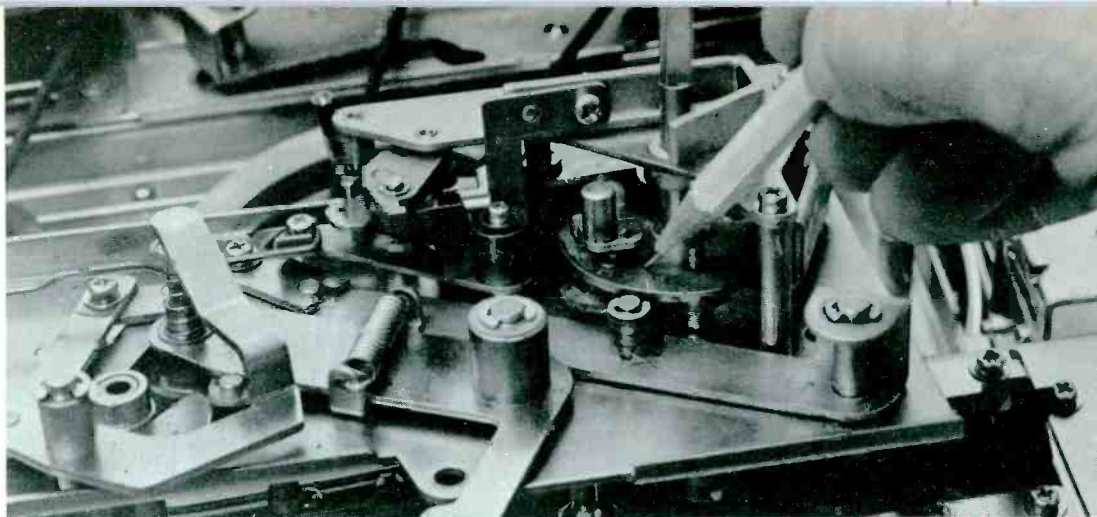
Step 7. The Pause function on this model works only in the Play mode; most work during recording, too. When you push the Pause knob forward, a long slide pivots the left brake lever, pressing the brake pad against the supply spindle. It also pivots another long lever which, via a set of crossed-wire springs, moves the pinch roller back from the capstan, and pulls the pressure pads away from the heads. The tape stops. If you push the knob to the right as it moves inward, it locks. To unlock it, and let the tape resume playing, push the knob leftward.



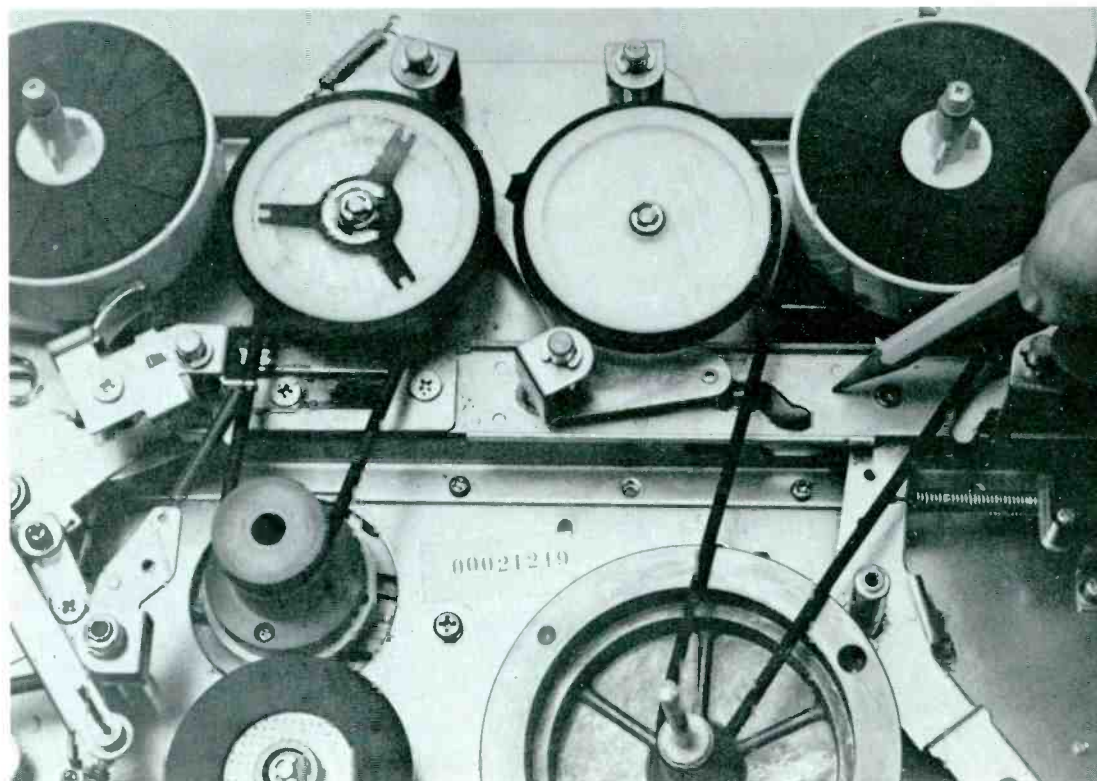
Step 8. The model pictured here has three speeds. The Speed-Selector knob rotates a cam beneath the base plate. Steps on the cam pivot a forked lever, which moves the fly-wheel belt from one groove to another on the motor pulley. A spring, connected between the lever and the base plate, holds the lever against the chosen step on the cam.



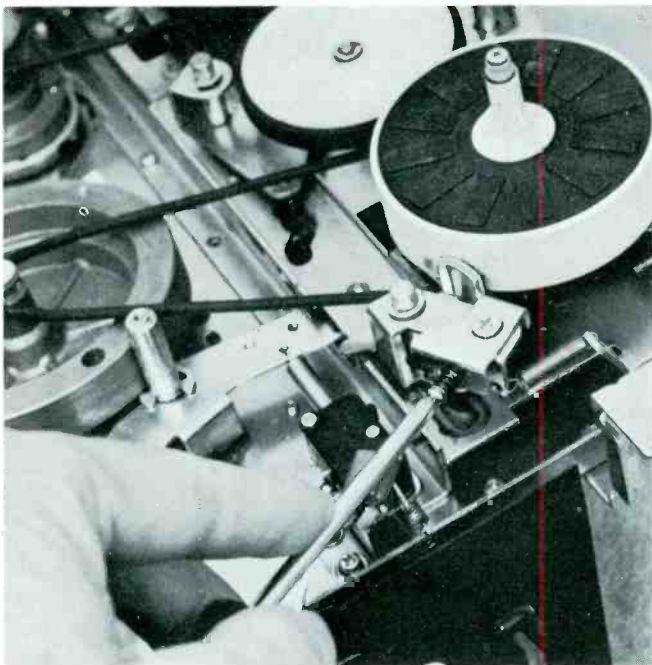
**Step 9.** Operation of a cam-type function-selector mechanism resembles that in pushbutton versions. However, operations are put together differently. For example, Fast-Forward is merely an extension of Play operation. A serrated cam beneath a large plate takes the place of slides and buttons. When you turn the function knob from Stop to Play, a large pin on the cam pivots a lever, pressing the pinch roller against the capstan. If you rotate the function knob further, to Fast Forward, the pin releases the pinch-roller lever. A spring pulls the pinch roller back away from the capstan. That's **one** operation of the selector cam.



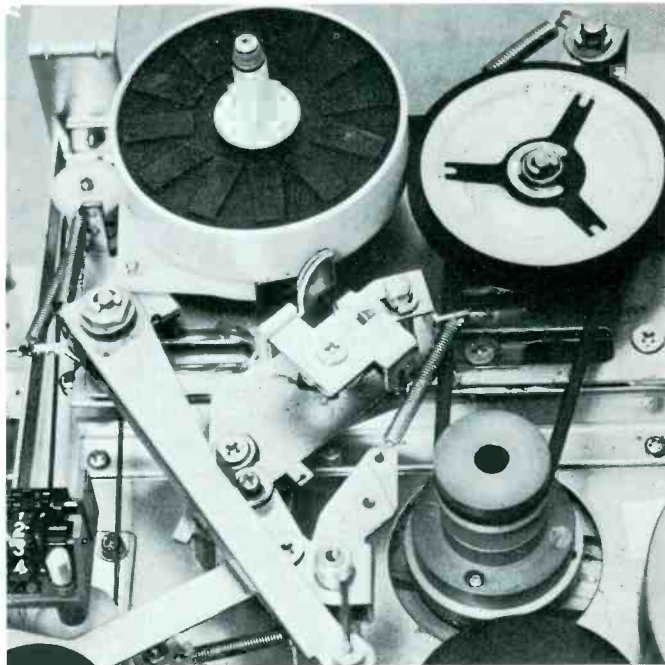
**Step 10.** The serrated cam also operates another long lever, which slides a shift lever. An arm, pivoted by the shift lever, moves a belt-driven idler against the takeup idler, pressing it against the takeup clutch drum. That's for Play position. When you move the function knob more, to Fast Forward, the cam pivots another lever which raises the takeup idler high enough to contact the takeup spindle directly. That turns the spindle at high speed.



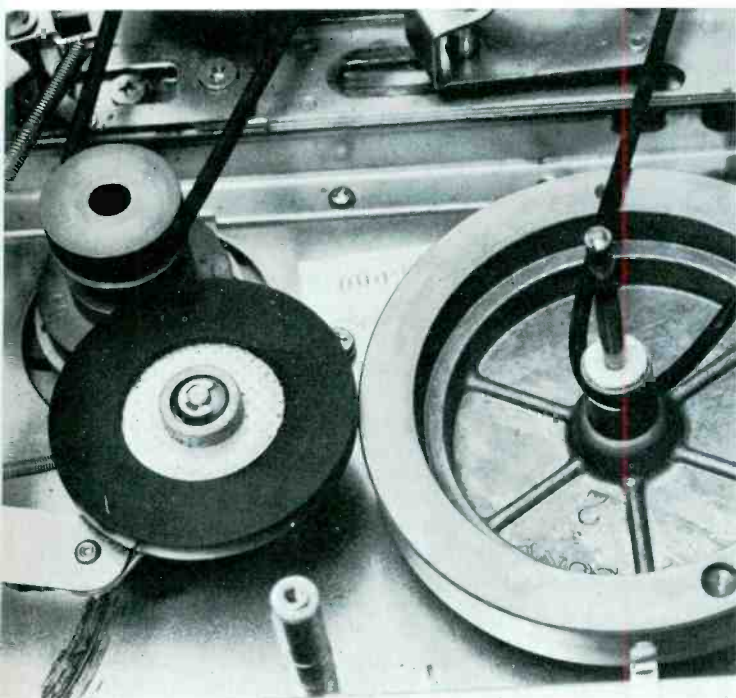




**Step 11.** The shift lever mentioned in Step 10 also pivots the brake arms, moving the pads away from the spindles. This takes place in both Play and Fast Forward modes.



**Step 13.** When you move the function knob from Stop to Rewind, the cam pivots the connecting lever in the opposite direction, sliding the shift lever to the left. The shift lever forces the belt-driven idler to the left, pressing the rubber tire directly against the rewind (supply) spindle, causing it to spin rapidly in reverse. Other operations, such as brakes, go the same as for Fast Forward.



**Step 12.** Still another lever (visible in the photo with Step 11) is operated by the shift lever, pulling on a long rod. The rod pivots an idler lever, pressing a rubber-rimmed idler against the motor pulley and the flywheel. That's what pulls the tape along, since the flywheel "axle" is the capstan.

### Summary

*This and the past two Workshop sessions should leave you with a working comprehension of the mechanics in typical open-reel tape recorders. A logical approach—cleaning, inspecting, adjusting, and then studying the machine in operation—should lead you to expert diagnosis.*

*Again we promise, if the Workshops truly help you in servicing tough mechanical problems, to conduct others for you. One on cassette machines is in the works, and later one for eight-track recorder/players. Let the editor know if you want to see them.* □

# What would you expect an IMA to do?



- Perform SMPTE intermodulation analyses quickly and easily, even in the millivolt range?
  - Measure amplifier noise?
  - Measure transistor noise?
- Evaluate magnetic tape drop-out?
- Test oscillator amplitude stability?
- Measure tape recording distortion?
- Evaluate phono stylus wear and tracking?
  - Test electromechanical transducers for intermodulation?

*The Crown IMA does all of it. Internal intermodulation distortion is less than 0.005%. Write us for more complete information and application notes.*

 **CROWN** INTERNATIONAL  
1718 W. MISHAWAKA ROAD ELKHART, INDIANA 46514 219-294-5571

For More Details Circle (13) on Reply Card

# BOTTOMS UP



Start saving the gray bottom flaps with the GE monogram from GE entertainment receiving tube cartons. They're worth valuable awards to independent service dealers and technicians in a fabulous gift bonanza program from General Electric.

The gift list includes some 43 items ranging from sporting equipment to home appliances, from diamond jewelry

to distinctive luggage, from globes and books to calculators and Attend-a-Phones. It even includes the much prized Polaroid SX-70 camera and American Experience weekend vacations at any one of 101 prestigious resorts.

**BOTTOMS UP!!!** Redeem your flaps by November 30, 1974. Full details at your authorized distributor.

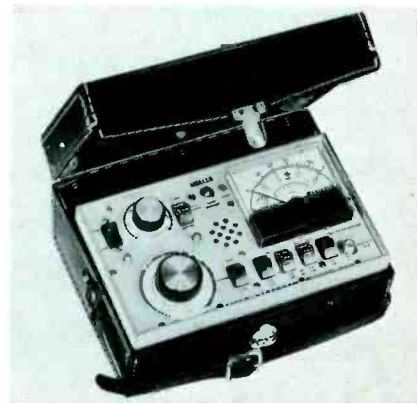
TUBE PRODUCTS DEPARTMENT  
GENERAL ELECTRIC COMPANY  
OWENSBORO, KENTUCKY 42301

**GENERAL  ELECTRIC**

## test equipment report

*These features supplied by the manufacturers are listed at no-charge to them as a service to our readers. If you want factory bulletins, circle the corresponding number on the Reply Card and mail it to us.*

### Field Strength Meter



Sadelco, Inc. has introduced a VHF/UHF professional field strength meter. Model FS3B features a built-in loudspeaker, precision gear drive, and 1 dB accuracy. Other features include a logarithmic scale, direct reading VSWR and return-loss scales, voltage-regulated battery supply, gold-plated attenuator switches, and a safety switch that turns power off when the cover is closed.

For More Details Circle (35) on Reply Card

### Programmer Kit

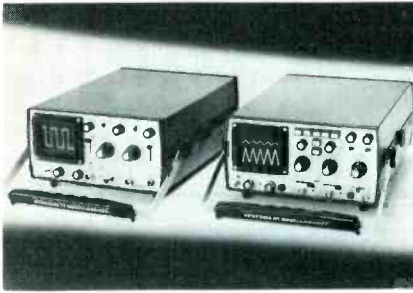
The Rig-A-Jig accessory yoke-programmer kit by GTE Sylvania makes it possible to use tube-sweep test jigs for testing solid-state color TV receivers. The CK1900X has a self-contained HV meter, and offers the option of using the focus supply in the receiver or a supply built in the programmer. The receiver is connected to the programmer, where the inductance of the yoke is matched by one of an assortment of patented plugs, and the programmer is connected to the test jig.

The CK1900X package includes complete listings of set-up information, covering 48 brands and 7000 models. Color TV receivers are listed by manufacturer and chassis number, and the code number indicates the proper programmer plug and adapter/extender combination to match the test jig.

For More Details Circle (36) on Reply Card



## Portable Scopes



Two portable, solid-state precision DC-to-15 MHz triggered scopes are

available from **Systems Electronics, Inc.** Model 77 (single-trace) and Model 87 (dual-trace) feature color-coded vertical and horizontal controls for rapid reading, an "easy-grip" carrying handle that doubles as a three-position tilt stand, and a pressure-fitted pop-off cabinet which requires no tools to open for servicing.

Specifications include a flat-face 8 X 10 division CRT and 15 MHz bandwidth. Both scopes measure 4-7/8 X 10 X 14-5/8 inches. Model 77 sells for \$550.00, Model 87 for \$625.00.

For More Details Circle (37) on Reply Card

## Electronic Counter

Model 5381 80-MHz counter is available from **Hewlett-Packard**. Designed for use in production line testing, service, calibration, and maintenance, the unit is said to remain accurate even under adverse temperature and line voltage conditions.

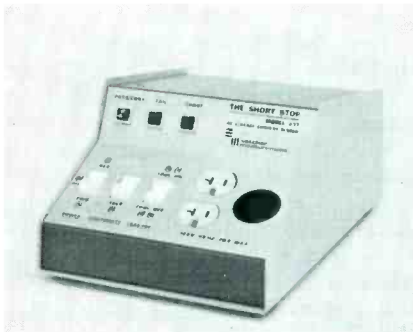
In wide-open settings, the counter can take 200 volts (peak AC + DC) without harm; it also features crystal oscillator time bases. Voltage regulation holds the oscillators to  $\pm 1$  ppm with 10% line variation.



Model 5381 sells for \$249.00.

For More Details Circle (38) on Reply Card

## AC-Leakage Current Tester



The Short Stop Model 311 AC-leakage current tester is designed to quickly identify an electrical defect in 120V equipment before it can become

a safety or fire hazard. The unit meets OSHA requirements by detecting any leakage from 0.5 mA up to a dead short and displays the condition on neon lamps.

Features include ten times the sensitivity offered by ground fault interrupters, accurate simulation of normal body impedance, built-in calibration standard, ground wire continuity check, and independent high and low current solid-state circuits.

Model 311 by **Sotcher Measurement** sells for \$189.00, complete with detailed instructions and a shockproof test pad.

For More Details Circle (39) on Reply Card

## Hand-Sized VOM

Model 310-Type 3 hand-sized VOM features a rugged thermoplastic case with easy-to-grip finger tread finish, a high-impact resistant front cover, and an easy-access battery and fuse compartment with a positive-lock slide latch. To free one hand, Model 310 can be converted into a common probe by unscrewing the tip from the black lead and placing it into a special jack on the top of the tester.

The meter movement is diode-protected against accidental overloads, the RX1 ohms range is guarded by a fuse, and the voltage ranges are

protected by high impedance. Sensitivity is 20,000 ohms per volt DC and 5,000 ohms per volt AC. Model 310 has 18 ranges that can be read on 3 arcs and it is self-shielded to provide accurate readings.

Available from **Triplett Corp.**, Model 310-Type 3 sells for \$48.00.

For More Details Circle (40) on Reply Card

**For More Information  
On Items Advertised  
Use Our  
Reader Service Cards**



# Fastatch<sup>®</sup>

## THE RIGHT CONTROL. THE FIRST TIME.

Fastatch is Centralab's precise, complete answer to control replacement in radio, TV, stereo and auto radio. It makes possible more than 9 billion combinations — thus your Centralab Fastatch Distributor can serve you best — now. The Fastatch snap-together control exceeds OEM requirements because of these built-in features for constant service.

- Snap together, permanent locking, anti-backlash construction on dual and twin controls.
- No alignment or twisting of controls.
- Shafts can't loosen or pull out.
- No cutting of shafts.
- Universal terminals replace printed circuit, wire wrap and hole type terminals.

**WHEN YOU NEED A CONTROL  
YOUR FASTATCH DISTRIBUTOR  
IS THE FIRST MAN TO SEE**

*Get the right replacement faster  
with 8 Centralab service kits.  
See your FASTATCH  
Distributor for complete details*

DISTRIBUTOR PRODUCTS



**CENTRALAB**

Electronics Division

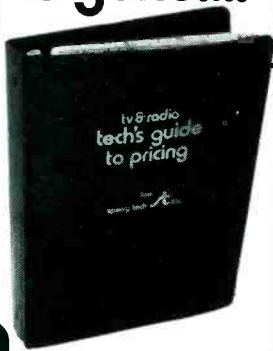
GLOBE-UNION INC.

5757 NORTH GREEN BAY AVENUE  
MILWAUKEE, WISCONSIN 53201

For More Details Circle (14) on Reply Card

service breakthrough

Guesswork is gone!...



in flat rate pricing!

Now, for the first time, one compact book guides you through the pricing hazards encountered in today's major categories of TV and radio repair. No more guess work. The building block system automatically provides an accurate pricing method for each step or adjustment involved. Each step is priced according to its complexity or magnitude. Also, there's a bonus section in the book that provides new business planning insight, that gives you an edge in all areas of pricing. **It's simple to use!** 1... index to the product repair. 2... total times for each repair. 3... convert time to price on the calculator page. (converts time to price in any area of the U.S.). Order now! A must for every shop owner... **Don't delay another profit day** simply fill out and mail the coupon below.

**\$18<sup>00</sup>** per issue, postpaid.

(Nebr. residents add city and state sales tax)

tv & radio  
tech's guide  
to pricing

sperry tech inc.

P.O. Box 5234  
Lincoln, NE. 68505

- More information please.  
 My check or money order enclosed.

NAME \_\_\_\_\_  
COMPANY \_\_\_\_\_  
ADDRESS \_\_\_\_\_  
CITY \_\_\_\_\_ STATE \_\_\_\_\_ ZIP \_\_\_\_\_

For More Details Circle (15) on Reply Card

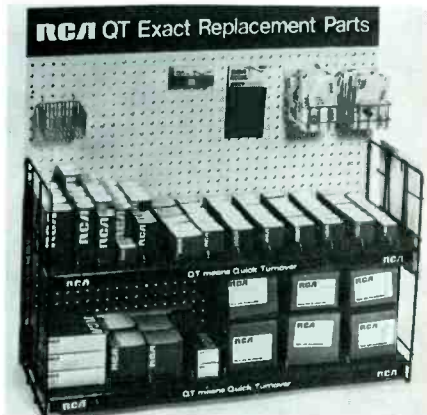
## productreport

These features supplied by the manufacturers are listed at no-charge to them as a service to our readers. If you want factory bulletins, circle the corresponding number on the Reply Card and mail it to us.

### Parts Rack

RCA Parts and Accessories is offering the QT parts rack, designed to hold the parts included in the RCA Dealer QT (for quick turnover) Parts Program. The program enables servicing dealers to save time and money by having the most frequently needed RCA parts readily available.

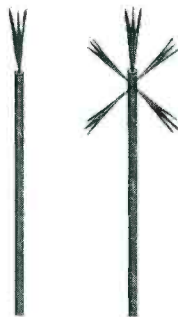
The new rack doubles as an attractive shelf arrangement for storing parts and a parts inventory-control system that makes it easy to efficiently manage replacement parts. Measuring 30 X 36 X 11-3/4 inches, the rack can be set up on a countertop or workbench, or it can be wall mounted. It comes complete with 18 removable wire dividers to keep parts in place, two steel hanger brackets for blister-



packed parts, and two wire baskets for parts packed in pouches.

For More Details Circle (42) on Reply Card

### Nozzle Extension



The OMNI-SPRA nozzle extension that sprays in a 360° circle as well as out the end is available from Tech Spray. Designed for better cleaning of the backs and sides of components as well as the fronts, this servicing aid is being packed with all cans of BLUE SHOWER spray cleaner.

For More Details Circle (43) on Reply Card

### Digital Projects Handbook

Basic fundamentals of digital integrated circuits with charts, schematics, and eight easy-to-build projects for the hobbyist and experimenter are featured in the Digital Projects Handbook by the Calctro Division of GC Electronics.

The Handbook, catalog number FR-169, contains easily understood instructions for building digital projects such as the digital dice game, digital clock, digital burglar alarm, and other applications for all Calctro digital

### Security System

The No. 750 wireless residential security system is offered by PLC Electronics. Designed for installation by professionals in the electronics field, everything needed is in one package, including illustrated installation instructions.

For More Details Circle (41) on Reply Card

components. The Handbook sells for 50 cents.

For More Details Circle (44) on Reply Card

### Tool Kits

Two field service executive-styled tool kits, JTK-27 and JTK-37, are available from Jensen Tools and Alloys.

Kit JTK-27 includes more than 100 tools selected for maintenance of all types of electronic equipment, computers and business machines. Its extra-deep attache case also holds an optional 3-inch field scope and a VOM test meter. Kit JTK-37 supplements the JTK-27 by adding 30 heavy-duty, metal-working and breadboard-construction tools. Purchased together, the two kits include a complete assortment of tools and basic instruments for the field repair shop.



The JTK-27/37 electronics lab kit sells for \$585.00 with instruments, and for less if the instruments are excluded.

For More Details Circle (45) on Reply Card



# Now Channel Master guarantees the amplifiers you installed a year ago!

And two--and even three years ago--because all Channel Master Antenna Mounted Amplifiers and Home System Amplifiers made since January 1971 are guaranteed for four full years from date of manufacture!

- With Free Replacement anytime within the first year
- And Replacement at a Pro-rated Charge anytime within 3 years after that, giving you
- Full 4 Year Warranty Protection the strongest coverage in the antenna systems equipment industry!

It's possible because the reliability and performance of our Spartan Series Amplifiers have proved to be their own guarantee--and this performance and reliability have been engineered into the entire line!

So now, instead of the usual 90 day wondering whether the equipment you've installed is going to perform, rest in confidence--Channel Master is offering you the finest product with the strongest warranty protection in the business!

**Channel Master Antenna Systems Equipment with 4 Year Warranty Protection!**



Check with your Channel Master Distributor for a listing by model number of units covered.

**CHANNEL MASTER  
DIV. of AVNET, INC.  
ELLENVILLE, N.Y.**

For More Details Circle (16) on Reply Card

# audio systems report

*These features supplied by the manufacturers are listed at no-charge to them as a service to our readers. If you want factory bulletins, circle the corresponding number on the Reply Card and mail it to us.*

## 8-Track Cartridge Cleaning Kit

The Recorder Care Division of **Nortronics Company, Inc.** has introduced the QM-181 8-track cartridge life extender for cleaning magnetic heads in all foreign and domestic 8-track recorders and players.

The kit features a non-abrasive endless belt of non-woven polyester fabric which safely removes accumulated dirt and oxide deposits from recording heads, and a sensing tab that ensures proper indexing to clean the entire head face. The QM-181 is also supplied with liquid cleaner which is applied to dissolve heavier oxide and dirt deposits. QM-181 is safe for the most delicate head surfaces.

For More Details Circle (46) on Reply Card

## Cassette Player



Model 12R150 automatic cassette car-stereo tape machine plays both sides of stereo cassettes continuously and automatically. Programs will

switch automatically or may be selected by pushbutton. Indicator lights show direction of tape movement, and tape can be run at high speed for both fast forward and rewind, allowing quick location of the exact segment of the program desired.

Other features include all solid-state amplifier with integrated circuits, 20 watts of power, slide controls, and a dust door to protect the front load slot. The player may be used with any vehicle having 12-volt DC negative-ground power.

Offered by **RCA Parts and Accessories**, Model 12R150 sells for \$112.95.

For More Details Circle (47) on Reply Card

## Stereo Preamp

Number 30-5015 stereo preamplifier is designed to adapt a magnetic cartridge to an amplifier not equipped with a stereo preamp. Available from the Audiotex Division of **GC Electronics**, the preamp plugs directly into the amplifier to increase fidelity and volume. It features solid-state circuitry, operates on AC, and is RIAA equalized.

For More Details Circle (48) on Reply Card



## Audio Adapters

Audio "Y" adapters for interconnecting mixers, amplifiers, microphones, tape decks, tuners, and test equipment are available from **Switchcraft, Inc.**

391Q "Q-G" (quick-ground) Y adapters give the technician wide flexibility in adapting/connecting audio circuitry and components. "Q-G" Y-adaptor cabling is 2-conductor, shielded with a durable outer jacket. Adapters are two feet long with a molded Y-junction at the center point; molded junction has strain relief for all cables, and protection against moisture, dust, dirt, and abuse. The 391Q adapters sell for \$16.10. □

For More Details Circle (49) on Reply Card

NOW  
**SANYO**  
Original Replacement Parts  
for  
Radio ■ Stereo ■ Television  
All Out-of-Warranty Replacement Components

Available from your local  
J. W. Miller Distributor



Sanyo National Representative  
**BELL INDUSTRIES / J. W. Miller Division**  
19070 REYES AVENUE • P.O. BOX 5825 • COMPTON, CALIFORNIA 90224

For More Details Circle (17) on Reply Card

give  
to the  
**MARCH OF DIMES**

## FREE CATALOG

### HARD-TO-FIND PRECISION TOOLS

Lists more than 2000 items—pliers, tweezers, wire strippers, vacuum systems, relay tools, optical equipment, tool kits and cases. Also includes ten pages of useful "Tool Tips" to aid in tool selection.

**JENSEN TOOLS**  
4117 N. 44th Street, Phoenix, Ariz. 85018



For More Details Circle (18) on Reply Card  
ELECTRONIC SERVICING



# antenna systems report

These features supplied by the manufacturers are listed at no-charge to them as a service to our readers. If you want factory bulletins, circle the corresponding number on the Reply Card and mail it to us.

## Antenna Rack

A compact outdoor antenna rack that displays as many as nine boxed RCA Permacolor antennas in less than two square feet of floor space is available from RCA Parts and Accessories.

The MU-1937 antenna rack is constructed of gold-tone anodized rails with blue and white side panels, and measures 18-1/2 X 16-1/2 X 28-1/2 inches. It is assembled easily and comes with all necessary hardware and instructions. Included with the rack are two multi-angle mast brackets for displaying one or more Permacolor antennas or a 4BG00 antenna mock-up.

For More Details Circle (50) on Reply Card

## Field Strength Meter

Model ASM-105 portable field strength meter is designed for field checks of antenna radiation. It can be used to tune antennas for peak radiating efficiency, as well as making comparative tests of various transmitters and antenna system installations.



The ASM-105 requires no internal power, operating entirely from the RF field, and covers the frequency range from 27 MHz through 225 MHz.

Available from **Ascom Electronic Products**, Model ASM-105 field strength meter sells for \$15.95.

For More Details Circle (51) on Reply Card

## Matching Harness



A new tapered line 300-ohm matching harness for combining identical UHF antennas into a single downlead has been introduced by **Jerrold Electronics**. Model JSL-U is useful where vertical stacking of UHF antennas is required for increased gain and added vertical capture area. Since the JSL-U causes extremely low loss, stacking gain is better than 2.5 dB; theoretical maximum stacking gain is 3.0 dB. The harness can also be used as a low-loss mixer to combine two identical UHF antennas which are oriented in different directions.

The JSL-U stacking harness sells for \$4.95.

For More Details Circle (52) on Reply Card

# T & T VALUE SALE

I.C.C. NEW JOBBER BOXED  
77% Off List

<input type="checkbox"/> 1B3.....5 for \$5.10	<input type="checkbox"/> 6HQ5.....5 for \$ 6.55
<input type="checkbox"/> 1V2.....5 for \$3.11	<input type="checkbox"/> 6HV5.....5 for \$11.65
<input type="checkbox"/> 2AV2.....5 for \$4.08	<input type="checkbox"/> 6JC6.....5 for \$ 5.80
<input type="checkbox"/> 3A3.....5 for \$5.23	<input type="checkbox"/> 6JE6.....5 for \$11.44
<input type="checkbox"/> 3AT2.....5 for \$5.06	<input type="checkbox"/> 6JS6.....5 for \$ 9.54
<input type="checkbox"/> 3GK5.....5 for \$5.00	<input type="checkbox"/> 6JU8.....5 for \$ 5.75
<input type="checkbox"/> 3HA5.....5 for \$4.95	<input type="checkbox"/> 6KA8.....5 for \$ 6.35
<input type="checkbox"/> 4BZ6.....5 for \$4.85	<input type="checkbox"/> 6KE8.....5 for \$ 7.90
<input type="checkbox"/> 5GH8.....5 for \$6.10	<input type="checkbox"/> 6KM6.....5 for \$11.75
<input type="checkbox"/> 6AX4.....5 for \$4.95	<input type="checkbox"/> 6KN6.....5 for \$13.80
<input type="checkbox"/> 6AY3.....5 for \$4.85	<input type="checkbox"/> 6KT8.....5 for \$ 7.00
<input type="checkbox"/> 6BK4.....5 for \$9.60	<input type="checkbox"/> 6KZ8.....5 for \$ 5.30
<input type="checkbox"/> 6CG3.....5 for \$5.05	<input type="checkbox"/> 6LB6.....5 for \$11.00
<input type="checkbox"/> 6CG8.....5 for \$5.60	<input type="checkbox"/> 8FQ7.....5 for \$ 3.85
<input type="checkbox"/> 6DQ6.....5 for \$6.95	<input type="checkbox"/> 12AX7.....5 for \$ 3.60
<input type="checkbox"/> 6DW4.....5 for \$4.83	<input type="checkbox"/> 12GN7.....5 for \$ 7.19
<input type="checkbox"/> 6EH7.....5 for \$4.95	<input type="checkbox"/> 17JZ8.....5 for \$ 4.65
<input type="checkbox"/> 6EJ7.....5 for \$4.65	<input type="checkbox"/> 21GY5.....5 for \$ 6.00
<input type="checkbox"/> 6FQ7.....5 for \$3.85	<input type="checkbox"/> 23Z9.....5 for \$ 5.65
<input type="checkbox"/> 6GF7.....5 for \$6.85	<input type="checkbox"/> 31LQ6.....5 for \$11.50
<input type="checkbox"/> 6GH8.....5 for \$4.05	<input type="checkbox"/> 33GY7.....5 for \$ 8.30
<input type="checkbox"/> 6GJ7.....5 for \$3.91	<input type="checkbox"/> 38H7.....5 for \$ 9.45
<input type="checkbox"/> 6GU7.....5 for \$5.40	<input type="checkbox"/> 38HK7.....5 for \$ 9.25
<input type="checkbox"/> 6HA5.....5 for \$4.95	<input type="checkbox"/> 42KN6.....5 for \$13.25

\*Free: Weller Soldering Gun Kit with 100 tube order.

RCA NEW JOBBER BOXED  
75% Off List

<input type="checkbox"/> 6FQ7.....5 for \$ 4.19	<input type="checkbox"/> 6JE6.....5 for \$12.44
<input type="checkbox"/> 6GH8.....5 for \$ 4.37	<input type="checkbox"/> 6JS6.....5 for \$10.35
<input type="checkbox"/> 6BK4.....5 for \$10.44	<input type="checkbox"/> 31LQ6.....5 for \$11.31

TRANSISTORS XACT REPLACEMENT (Boxed)  
80% Off List

<input type="checkbox"/> SK300E.....5 for \$2.35	<input type="checkbox"/> SK3035.....5 for \$9.15
<input type="checkbox"/> SK3009.....5 for \$3.90	<input type="checkbox"/> SK3036.....5 for \$9.75
<input type="checkbox"/> SK3018.....5 for \$2.25	<input type="checkbox"/> SK3040.....5 for \$3.75
<input type="checkbox"/> SK3020.....5 for \$2.20	<input type="checkbox"/> SK3041.....5 for \$4.20
<input type="checkbox"/> SK3024.....5 for \$3.15	<input type="checkbox"/> SK3042.....5 for \$6.20
<input type="checkbox"/> SK3025.....5 for \$4.50	<input type="checkbox"/> SK3054.....5 for \$4.50
<input type="checkbox"/> SK3026.....5 for \$3.00	<input type="checkbox"/> SK3114.....5 for \$2.40

GENERAL

<input type="checkbox"/> 3.58 crystal osc.....6 for \$3.00	<input type="checkbox"/> 6500 PIV ITT Focus Rect.....10 for \$4.00
<input type="checkbox"/> Zen. Voltage Tripler 212-136 ea. \$3.95.....3 for \$10.00	<input type="checkbox"/> Blue Lateral Magnets incl. P.R.....2 for \$2.50
<input type="checkbox"/> 2.5 amp 1000 PIV IR170.....20 for \$3.00	<input type="checkbox"/> Color Burst Boost Rectifier.....7 for \$2.00
<input type="checkbox"/> 66 meg res—53 meg res.....10 for \$3.00	<input type="checkbox"/> 19" & 25" Color Boosters 21" Color Boosters.....3 for \$11.95
<input type="checkbox"/> 47mfd / 160v r.1.....5 for \$1.00	<input type="checkbox"/> 60 min. Irish Cassette Tapes.....6 for \$2.50
<input type="checkbox"/> GE Parallel tuner inc. 6L38-6GK5.....\$3.95	<input type="checkbox"/> CM Series Tuner incl. 6CG8-6GK5.....\$3.95
<input type="checkbox"/> Jap Phono arm incl. cartridge and needle.....\$1.00	<input type="checkbox"/> Xcelite Service Master Kit.....\$24.95

BATTERIES GLOBAL  
METAL JACKET POWER PACKER

<input type="checkbox"/> D Size.....35c list—24 for \$3.60	<input type="checkbox"/> C Size.....35c list—24 for \$3.60
<input type="checkbox"/> Penlite.....4/\$1.00 list—24 for \$2.40	<input type="checkbox"/> 9 Volt.....list 69c—10 for \$2.50

ANTENNA SUPPLIES

<input type="checkbox"/> Finco MATV Mod. G922 300 ohm input 4-300 ohm output.....\$29.95	<input type="checkbox"/> Finco #3020 2 Way Signal Splitter UHF VHF.....\$1.75
<input type="checkbox"/> JFD Signal Splitter 82 Channel SS21.....\$1.50	<input type="checkbox"/> JFD BC2 Two Set Coupler.....\$1.50
<input type="checkbox"/> 72 ohm to 300 ohm matching transformer.....\$1.25	<input type="checkbox"/> 2 set 72 ohm coupler.....\$2.95
<input type="checkbox"/> 4 set 72 ohm coupler.....\$3.95	<input type="checkbox"/> 1000 ft. foam wire Columbia #22.....\$23.95
<input type="checkbox"/> 500 ft. Coax White 72 ohm.....\$16.95	<input type="checkbox"/> Finco CA 9 Color Antenna.....\$6.90
<input type="checkbox"/> Finco CA 13 Color Antenna.....\$9.90	

Minimum orders \$35.00 F.O.B. Brooklyn  
Catalogs \$1—Refundable upon your order  
C.O.D. Cash only.

## T & T SALES CO.

4802 AVENUE K  
BROOKLYN, N. Y. 11234  
Phone: (212) 241-5940

For More Details Circle (20) on Reply Card

## GOOD TOOLS!

### 15 Watt Miniature Plug-In Soldering Iron



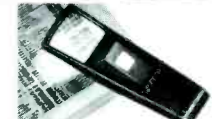
ORYX — the tiny iron for service work, lab, production. Needs no transformer, weighs only an ounce plus cord. Heats so quickly — reaches 725°F in about a minute. Light weight, small size let you work all day without fatigue. Just the thing for tiny components, delicate circuits, working in close quarters. Many replaceable tips.

### Controlled- Temperature Soldering Iron



ORYX Model 50 iron affords close control of temperature, from 400 to 750° F. 50-watt element gives fast heat, quick recovery from heavy joint loads. Temperature adjustable while iron is on. Ideal for semiconductors, delicate components that could be damaged by heat. Many replaceable tips, in various shapes, sizes.

### Magna-Lite® Illuminated Magnifier



MAGNA-LITE, with new high power lens, lets you focus on fine detail regardless of lighting conditions. Its battery operated light beam bathes magnified area with just the right amount of light for perfect viewing. Weighs just 1 1/2 ounces; fits the hand like a glove. Comes with replaceable penlight batteries.

Write today for  
**FREE** Electronic Tools  
CATALOG! & Test Instruments

TEL-67  
ORLYX  
TEL-67  
TEL-VAC  
INSTRUMENT  
COMPANY  
14674 MAYMER STREET  
VAN NUYS, CALIF. 91405

For More Details Circle (19) on Reply Card

# SPRAY AWAY THE RACKET.



Squeak. Whine. Whirr. Pssst! Silence. Quietrol did it again. Silenced those moving T.V. parts, with one squirt from the handy spray pack. Cleaned away dirt, dust, and crud. Without damaging anything... in any black and white or color set. Silence is golden. So is Quietrol.

Also available in bottles, and the new Silicone—"Silitron."

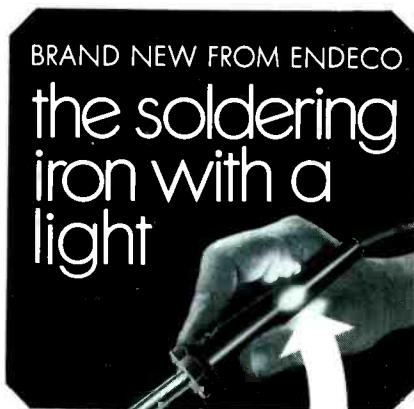
Product of



**QUIETROL**  
COMPANY

Spartanburg, South Carolina

For More Details Circle (21) on Reply Card



Exclusive new safety light shows when power is on  
MODEL 540S \$10.95 NET

Two heats—20w and 40w—to handle any job  
• On-off switch • Cool, unbreakable polycarbonate handle • Ironclad tips for longer life  
• Burn-resistant neoprene cord • 8 1/2" long, 2 oz • Converts to a desoldering iron with low cost attachment • Also desoldering irons and soldering/desoldering kits.

To locate your nearest distributor call toll-free 800-645-9200



5127 EAST 65TH ST.  
INDIANAPOLIS,  
INDIANA 46220  
PHONE 317/251-1231

enterprise  
development  
corporation

For More Details Circle (22) on Reply Card

## catalogs literature

Circle appropriate number on Reader Service Card.

**101. Channel Master**—has released a consumer-products catalog entitled "Channel Master '74—the Natural Sound". The 64-page color catalog features radios, clock radios, cassette player/recorders, modular stereo systems, 8-track equipment, auto entertainers, and portable TV sets.

**102. Fordham Radio Supply**—has announced a 32-page, illustrated discount mail-order catalog. Designed as a quick reference ordering guide for use by radio and TV technicians, electronic technicians, and hobbyists, the catalog includes tools, service and repair kits, tubes, test equipment, phono cartridges and needles, speakers and microphones, antennas, and components.

**103. GTE Sylvania**—offers a catalog describing its line of Pathmaker cable communications equipment. The 41-page catalog features Sylvania series 2000 Trunk Amplifier stations and describes the variety of transmission services that can be obtained with the equipment; transportation/distribution amplifier stations, plug-in modules, power supplies, passive devices and accessories are also described.

**104. International Rectifier Corp.**—makes available a handy, pocket-sized universal-replacement transistor crossover chart, which lists over 250 IR and competitive part numbers. The 8-1/2 X 3-1/2 inch card allows the user to quickly select the proper IR universal transistor to replace universal transistors made by other major suppliers, including Sylvania, RCA, GE, and Motorola.

**105. Nortronics Company**—has introduced a ten-page, two-color brochure describing their line of Recorder Care Kits. Included are ToteKit 1, 2, and 3 for cassette, 8-track cartridge, and reel-to-reel recorders and players, respectively; Inspection and Cleaning Kits

QM-6, 7, 8 and 9 for all machine types; and QM-5 Video Recorder Care Kit for video tape recorders.

**106. Perma Power**—has released a six-page, illustrated catalog of solid-state public-address sound systems. The catalog describes the complete line of Ampli-Vox equipment, covering almost all applications for portable sound systems. A comprehensive range of accessory items are also listed.

**107. Projector Recorder Belt Corp.** offers a catalog listing over 1800 belts available from stock for tape recorders, projectors, record players, dictating machines, and video recorders. A simplified cross-reference system combined with a special belt sizer makes ordering easy and reduces inventory for service and repair shops.


**108. RCA Parts and Accessories**—makes available a 16-page catalog of servicing aids for electronic technicians, featuring the RCA Industry Compatible Test Jig Program. The manual includes seven pages of photos to help identify the cables and adapters utilized with the test jig, as well as a comprehensive cross-reference chart. Descriptions of other RCA products and accessories are also included.

**109. Simpson Electric Company**—has released a 108-page Master Catalog containing comprehensive technical information on panel meters, meter relays, controllers, recorders, digital instruments, and test equipment. In loose-leaf form, the catalog is bound in a durable, hard cover, 3-ring binder for easy data change.

**OWN YOUR OWN PICTURE TUBE REBUILDING BUSINESS**

With Lakeside Industries rebuilding equipment you can rebuild any picture tube!


For complete details send name, address, zip code to  
**LAKESIDE INDUSTRIES**  
3520 W. Fullerton Ave.  
Chicago, Ill. 60647  
Phone: 312-342-3399



For More Details Circle (23) on Reply Card

**FREE ALARM CATALOG**

Full line of professional burglar and fire alarm systems and supplies. 80 pages, 400 items. Off-the-shelf delivery, quantity prices.

 **mountain west alarm**  
4215 n. 16th st., phoenix, az. 85016



For More Details Circle (24) on Reply Card



# bookreview

## Hi-Fi Stereo Handbook

**Author:** William F. Boyce

**Publisher:** Howard W. Sams & Co., Inc., 4300 West 62nd Street, Indianapolis, Indiana 46268

**Size:** 5-1/2 X 8-1/2 inches, 400 pages

**Price:** \$5.95 softbound

This book was prepared as a reference and guide for all persons interested in high-quality sound reproduction. For the beginner, it explains the difference between monophonic, stereophonic, and three-dimensional sound systems; the meaning of high fidelity; the different sources of program material; and the various kinds of distortion. The three major stages in hi-fi reproduction are thoroughly covered: the program-source equipment, preamplifier and amplifier sections, and the speaker system. For the audiophile, there is advice and instruction on selection, installation, and operation of equipment for all modes of four-channel sound, including discrete, derived, matrixed, synthesized, live, stored, and broadcast. The author also discusses the material needed for designing, selecting, and installing simple, medium, and complex systems to suit any taste and pocketbook.

## Auto Stereo Service & Installation

**Author:** Paul L. Dorweiler and Harry E. Hansen  
**Publisher:** Tab Books, Blue Ridge Summit, Pennsylvania 17214

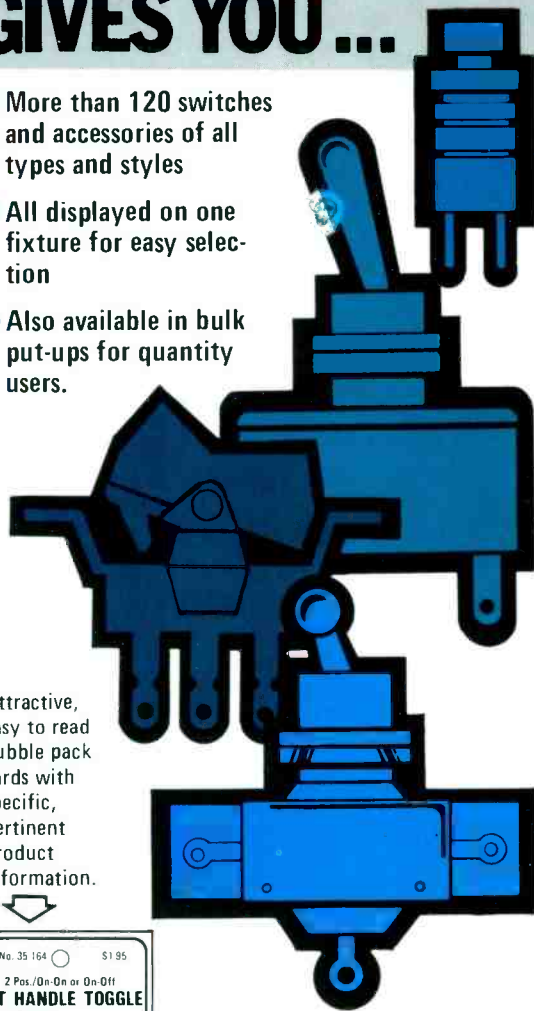
**Size:** 5-1/2 X 8-1/2 inches, 250 pages

**Price:** \$8.95 hardbound, \$5.95 softbound

A one-stop source of service information for all types of automotive stereo equipment, plus detailed installation procedures for FM radios, 8-track cartridge units, and cassette players is offered in this book. It covers every phase of installation, including mounting and adjustment of FM stereo receivers and tape players, and it tells how to get rid of troublesome interference caused by the automotive environment. Also included are 48 complete schematics representing 13 major manufacturers, plus many other diagrams and sketches. The book begins with a review of available popular units and a clear description of magnetic-tape theory. Readers will find it useful not only for their own servicing needs, but also as an aid in educating their customers. The rest of the book is devoted to servicing. The subject of general maintenance covers the mechanical aspects which consume much of the technician's time, including dial cord and lamp replacement, replacing controls, cleaning and adjusting tape players, demagnetizing and tape splicing. □

# BEFORE YOU BUY A SWITCH... CONSIDER THIS - ELECTROGRAFT GIVES YOU ...

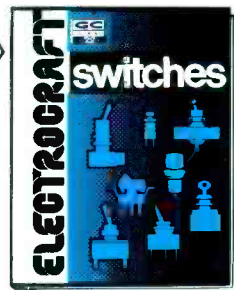
- More than 120 switches and accessories of all types and styles
- All displayed on one fixture for easy selection
- Also available in bulk put-ups for quantity users.



Attractive, easy to read bubble pack cards with specific, pertinent product information.



48 page catalog complete with technical specs, templates and cross reference also available



**GC ELECTRONICS**

DIVISION OF HYDROMETALS, INC.  
 ROCKFORD, ILLINOIS 61101 U.S.A.



# minus 62 INSTANT CHILLER

THE CHILLER THAT EXCEEDS THE STANDARD

For a long time -55°F was the standard for chilling sprays . . . because the colder the spray, the quicker intermittents are put into the failure mode

Now there's a new standard . . .

minus 62 INSTANT CHILLER chills to well below -62°F . . .

giving you better, faster servicing

The colder the better and minus 62 INSTANT CHILLER is the coldest



YOU CAN HELP US CONSERVE STEEL

MINUS 62 INSTANT CHILLER cans are refillable when empty. Take them to any participating distributor — he will credit you 5 cents for each can and return them to TECH SPRAY for refilling.



From **TECH SPRAY** where we find solutions for your problems  
Amarillo, Texas 79105

For More Details Circle (26) on Reply Card

## SOLDERING + DESOLDERING + RESOLDERING = SOLDER ABILITY

ELEMENTARY TO ELITE  
WORLD'S MOST PRACTICAL SOLDER HANDLING TOOLS

meets industries demands.....

with a COMPLETELY PORTABLE SOLDERING/DESOLDERING/RESOLDERING SYSTEM



**EDSYN**  
15958 ARMINA STREET  
VAN NUYS, CALIFORNIA 91406  
PHONE (213) 989-2324  
TELEX NO. 65-1469 EDSYNEX VAN

Ads in EEM, OTS, EBG,  
AE, TR, and EPAC Catalogs

Send for our FREE 16 page  
**SOLDER ABILITY**  
manual

For More Details Circle (27) on Reply Card

# photofactbulletin

PHOTOFACT BULLETIN lists new PHOTOFACT coverage issued during the last month for new TV chassis.

### ADMIRAL

Chassis 3K1902-9/04-14/09-3/09-4/15-5/16-4/17-2/20-1/22-1/87-7/87-8/88-2 ..... 1416-1  
Chassis 8W5B ..... 1416-1-A

### J. C. PENNEY

685-2211 (855-1962), 2211 ..... 1418-1

### J. C. PENNEY

2334 (855-2036) ..... 1420-1

### J. C. PENNEY

2336 (855-2077) ..... 1419-1

### MAGNAVOX

Chassis T989-01 thru T989-06/-08/-10 ..... 1418-2  
Remote Control Receiver 704084-1,  
Transmitter 704081-1 ..... 1418-2-A  
Remote Control Receiver 704078-3/-4,  
Transmitter 704061-1 ..... 1418-2-B

### PANASONIC

Chassis ETA-3, ETA-8 ..... 1417-1

### SANYO

21V55, 21V65 ..... 1416-2

### SEARS

562.40040300, 562.40090300 ..... 1419-2

### SHARP

2F-25 ..... 1418-3

### SYLVANIA

Chassis A12-1, A12-2, A16-1 ..... 1417-2

### SYLVANIA

Chassis E05-1, E05-13 ..... 1420-2

### TELEDYNE PACKARD BELL

Chassis 98C38, 98C42, 98C44 ..... 1420-3

### TRUETONE

WEG4419A-47 (2DC4419),  
WEG4420A-47 (2DC4420) ..... 1416-3

### TRUETONE

GEC4316B-47 ..... 1417-3

### TRUETONE

GEC4519A-57 (2DC4519) ..... 1419-3

If you've recently run across an unusual trouble symptom and have determined what caused it, why not pass the info on to the other readers of ELECTRONIC SERVICING. You'll not only be saving other technicians valuable troubleshooting time, you'll also be making a little extra change for yourself. Send a thorough description of the trouble symptom and the solution to:

**Troubleshooting Tips, ELECTRONIC SERVICING**  
1014 Wyandotte Street, Kansas City, Missouri 64105

ELECTRONIC SERVICING



# SERVICE ASSOCIATIONS

The past months have been busy ones for the service associations which have become increasingly active with various governmental committees that are concerned with consumer affairs.

For example, the Sub-Council On Product Performance And Service of the National Business Council For Consumer Affairs (a "blue-ribbon", 100-man committee of top business executives appointed by President Nixon) has released a report entitled "**Product Performance And Servicing**". Officials of both the National Alliance of Television & Electronic Service Associations (NATESA) and the National Electronic Service Dealers Association (NESDA) appear to be in general agreement with recommendations in the report. In brief, Dick Glass of NESDA states that NEA and NESDA have been working for these things for years, and Frank Moch of NATESA is pleased that the report includes many suggestions made by his organization.

Here are some of the recommendations from the report:

- electronic manufacturers are urged to improve the serviceability of their products and reduce the proliferation of parts;
- the status of service personnel should be upgraded;
- technical-training programs should relate directly to the skills needed for actual jobs in the industry;
- the committee urges expansion and upgrading of service training;
- manufacturers and trade associations are urged to establish standards for certification of service personnel;
- businesses should cooperate with and support the Better-Business Bureaus, law-enforcement agencies, publications and other media;
- everyone should help develop uniform state laws regulating electronic-servicing firms.
- availability of replacement parts should be given priority by manufacturers;
- third-party arbitration for settlement of complaints is urged; and
- servicers are requested to report details of service problems to the factories involved.

In addition, Frank Moch of NATESA, Dick Glass of NESDA and officials of EIA testified in April at the national Consumer Product Safety Commission about the safety of television receivers, and particularly the dangers from fires. Although recommendations to lessen dangers were given, all the testimony from these organizations seemed to agree there was far more danger from actions (or failure to act after a trouble occurred) on the part of the set owners and operators than could be blamed on poor components or design by the TV manufacturers.

The executive committee of National Appliance And Radio-TV Dealers (NARDA) has recommended that

membership be extended to all merchants who sell and service consumer products. Previously, only appliance and radio-TV dealers could be members. Another recommendation was to change the name to the National Association Of Retail Dealers of America. Reason for the changes seems to be the expectation of a broadening of the product lines carried by dealers formerly engaged only in appliances.

**Carl Babcoke**, Managing Editor of Electronic Servicing, was the after-dinner speaker at the spring convention of the Missouri Electronics Service Dealers Association (MESDA) held April 26th and 27th in Kansas City, Missouri. President Len Jacobs presided, and the arrangements were made by Mac Metoyer (shown seated at the head table).



Charles R. Couch, Jr., president of NESDA, recently spent three days in Washington. Although the principal reason for the trip was to attend the Advisory Committee On Mediation And Arbitration Of The Council Of Better-Business Bureaus, his activities included contacts with the FCC, the EIA, National Federation Of Independent Business, Mrs. Virginia Knauer, and the National Association Of Broadcasters. NESDA headquarters is located at 1715 Expo Lane, Indianapolis, Indiana 46224.

Officials of NATESA are enthusiastic about their new program called "COPE". COPE lists problems of servicers and suggests solutions, and is said to be an extensive project. For more details, write to: NATESA, 5908 South Troy Street, Chicago, Illinois 60629.

A joint investigation by the Rocky Mountain Better Business Bureau, the **Denver Post** newspaper, and the Colorado Professional Electronics Association (CPEA) has brought results that seem to indicate "free" service call ads are not really free. According to the **Denver Post**, a bad 6GH8 tube was installed in the color circuit of a Magnavox. Then several firms were called to service it. Charges varied from a low of \$28.50 to a high of \$32.95. Paul Dontje, Executive Director of CPEA, estimated his firm, which has a \$15 minimum service call charge, would have priced the repair at \$21.50. The BBB maintains such "free" service call offers are "bait-and switch".

The most ambitious trade magazine (even more remarkable because it is a state organization venture) I have noticed is the VEA REPORTER, published by the Virginia Electronics Association, Inc., of Norfolk, Virginia. Both the editing and printing are good, but most surprising was the size: 28 pages including 53 pictures! □

## The MARKETPLACE

This classified section is available to electronic technicians and owners or managers of service shops who have for sale surplus supplies and equipment or who are seeking employment or recruiting employees.

**Advertising Rates**  
in the Classified  
Section are:

- 25 cents per word  
(minimum \$3.00)
- "Blind" ads \$2.00  
additional
- All letters capitalized  
35 cents per word

Each ad insertion must be accompanied by a check for the full cost of the ad.

**Deadline for acceptance** is 30 days prior to the date of the issue in which the ad is to be published.

This classified section is not open to the regular paid product advertising of manufacturers.

## FOR SALE

**USE YOUR SCOPE (ANY MODEL, NO REWIRING) TO TEST TRANSISTOR IN/OUT CIRCUIT. SIMPLE INSTRUCTIONS \$1.00. SCHEK TECHNICAL SERVICES, 8101 SCHRIDER ST., SILVER SPRING, MARYLAND 20910. 10-73-12**

**UNUSUAL SURPLUS AND PARTS** Catalog. \$1. ETCO Electronics Dept. E.S., Box 741, Montreal "A" H3C 2V2 12-73-121

**COMPLETE ELECTRONIC SERVICE BUSINESS**—great opportunity for expansion. SAMS to date - Complete test equipment. Reason - leaving as missionary. Larry's, 407 Elm St., Shelbyville, Tn. 37160. 8-74-11

**4 POSITION** Picture Tube Rebuilding Plant. Modern 60" X 40" X 14" metal building. Will consider selling just the equipment. 109 Hansel St., New Iberia, Louisiana 70560, 318-369-6260. 8-74-11

**TELEVISION** Sales/Service located in Northeast Iowa. All modern equipment and lots of work. Nice opportunity for a young fellow wanting to go on his own. Write: Dept. 504, Electronic Servicing, 1014 Wyandotte St., Kansas City, Mo. 64105. 8-74-11

**CONSTRUCTION** plans \$1 each. Convert your television to instant-on. Test transistors, diodes, transformers, etc. with your ohmmeter. Test color crt's with b/w crt tester. Build tuner eliminator from junk TV. Build instant-on TV adaptor. Build a 12v Power supply for 1/3 the cost. Build a transistor tester in 10 minutes for pennies. Get all 7 plans for \$5.00—plus FREE "TV tips". William Morgan, Bruce, Miss. 38915. 8-74-11

## SERVICES

**OSCILLOSCOPE REPAIRS.** Send unit or write for details. ONG ELECTRONICS, INC., Box 209, Corning, New York 14830. 6-74-31

## WANTED

**WANTED—ELECTRONIC TECHNICIAN.** UNUSUAL OPPORTUNITY FOR ONE WELL QUALIFIED IN COLOR TV. TOP SALES AND SERVICE SHOP HAS 40 YEAR REPUTATION. WE MUST REPLACE RETIRING PARTNERS. MUST BE HONEST, EAGER TO LEARN, AND ENJOY SERVING PEOPLE. CONTACT: WELLS & LATHATTE, VICKSBURG, MS. 39180. 8-74-31

**WANTED:** Old Radio Books, Magazines, Diagram Manuals. Beitman, 1760 Balsam, Highland Park, Illinois 60035. 8-74-11

## EDUCATION-INSTRUCTION

**REPAIR TV TUNERS**—High Earnings; Complete Course Details, 12 Repair Tricks, Many Plans, Two Lessons, all for \$2. Refundable. Frank Bocek, Box 3236 Enterprise, Redding, Calif. 96001. 6-74-6t

**NOW!** Master Solid State Vertical Oscillator-Output Circuit problems. Latest instruction teaches current circuitry. \$1 brings lesson, details. Reidel, Box 9603, Denver, Colorado 80209. 7-74-tf

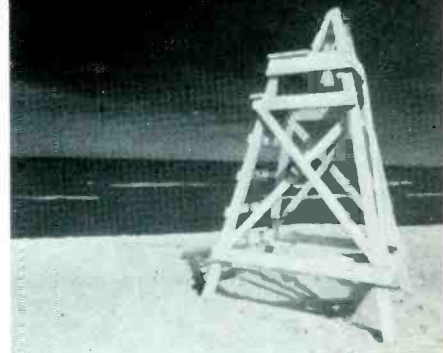
## advertisers' index

B & K Div., Dynascan Corp .....	7
Bell Industries .....	48
Bussman Mfg. Div., McGraw-Edison .....	25
Castle TV Tuner Service, Inc. . . . .	Cover 4
Centralab Globe-Union, Inc .....	45
Channel Master .....	47
Crown International, Inc .....	44
Edsyn, Inc .....	52
Enterprise Development Corp .....	50
GC Electronics .....	51
General Electric Company .....	1, 44
Heath/Schlumberger Instruments .....	23
Jensen Tools and Alloys .....	48
Lakeside Industries .....	50
Lectrotech, Inc .....	29
Mallory Distributor Products .....	3
Mountain West Alarm Supply Co. . . . .	50
Precision Tuner Service .....	Cover 2
Quietrole Company .....	50
Howard W. Sams & Company, Inc .....	Cover 3
Sperry Tech., Inc .....	46
Sprague Products Company .....	11
GTE Sylvania—Consumer Renewal .....	19
T & T Sales Company .....	49
Tech Spray .....	9, 52
Telvac Instrument Company .....	49
Tuner Service Corporation .....	5
Winegard Company .....	9, 31

**Take stock  
in America.**

**U.S. Savings Bonds**

**Last year 3,100 people  
stayed at the beach.  
Permanently.**



Of course they all drowned. But then, another 55,600 Americans were killed in motor-vehicle accidents. And 17,600 died from falling. Fire claimed another 6,300 lives.

The figures go on and on. But maybe you get the point.

Don't let us hear about you by accident.

**National  
Safety  
Council**



If you don't like thinking about safety, think where you'd be without it.

A reminder from the National Safety Council. A non-profit, non-governmental public service organization. Our only goal is a safer America.



# The easiest-to-follow of all guides to electronic servicing.

## Sams 1-2-3-4 Service System series.

If it's electronic and if it's involved in home entertainment — there's a Sams 1-2-3-4 Service System guide to help you service it easily and right. The 1-2-3-4 System shows in logical, easy-to-follow sequence, how to diagnose, locate, isolate and pinpoint troubles in radios, stereos,

tv sets, cassettes, turnables, and calculators. Follow the system and you can't miss. All six of the guides in the highly popular 1-2-3-4 Series are described here, along with three other helpful Sams guides in related fields. You'll want them all.

### The 1-2-3-4 System Series

#### 1-2-3-4 SERVICING AUTOMOBILE STEREO (2nd Edition)

by Forest H. Belt

Follow its easy-method steps and you'll trouble-shoot and service automobile cassette, fm multiplex, and stereo equipment with no wasted time. And the job will be done right. 240 pages, softbound.

No. 20975 \$4.95

#### 1-2-3-4 SERVICING CASSETTES

by Forest H. Belt

The complete step-by-step directions for discovering and correcting cassette faults and problems in a minimum of time and with a maximum of accuracy. 240 pages, softbound.

No. 20922 \$5.25

#### 1-2-3-4 SERVICING TRANSISTOR COLOR TV

by Forest H. Belt

Outlines in detail the simple, step-by-step procedure for avoiding false starts in pinpointing transistor color-tv problems, and for fixing them fast every time. Includes latest color-tv circuitry. 264 pages, softbound.

No. 20777 \$4.95

#### 1-2-3-4 SERVICING STEREO AMPS

by Forest H. Belt

Follow the simple 1-2-3-4 system for servicing stereo amps, as outlined in this complete guide, and you locate and solve the problem without losing time by making false starts and going down "blind alleys." 240 pages, softbound.

No. 20912 \$4.95

#### 1-2-3-4 SERVICING HI-FI TURNTABLES

by Forest H. Belt

The 1-2-3-4 servicing method is the time-saving way to restore hi-fi turntables to correct operation. Use it for a speedy check of the machine's mechanical and electronic sections, assemblies, and parts, eliminating as you go until you've pin-pointed the trouble... and then follow its easy repair instructions. 192 pages, softbound.

No. 21032 \$4.95



#### 1-2-3-4 SERVICING TRANSISTOR CB AND TWO-WAY RADIO

by Forest H. Belt

Thorough coverage, by the popular 1-2-3-4 servicing method, of every step needed to assure quick and complete servicing of CB and two-way radio equipment. Also covers rules and regulations governing repair and use. 256 pages, softbound.

No. 20965 \$5.25

#### ... and 3 Other Service Helps from Sams

#### ELIMINATING ENGINE INTERFERENCE (2nd Edition)

by John D. Lenk

Practical instructions on how to solve a major problem common to all communications equipment. Shows how to identify and isolate the specific components that create interference and generate noise, and how to install shields and noise-suppression equipment. 128 pages, softbound.

No. 21004 \$4.50

#### CB RADIO SERVICING GUIDE (3rd Edition)

by Leo G. Sands

A complete and practical guide for servicing all types of CB equipment. Includes tuning, testing and troubleshooting of both tube and transistor equipment, covers FCC regulations, and presents step-by-step analysis of transmitter circuits. 160 pages, softbound.

No. 21074 \$4.95

#### ELECTRONIC CALCULATORS

by H. Edward Roberts

This new book is the first complete source for information on calculator design, construction, and repair. Covering calculator memories, displays, interfacing with hard-copy equipment, and servicing, it is a valuable aid for all who must understand and service the rapidly growing field of miniature electronic calculators. 176 pages, softbound.

No. 21039 \$5.95

**HOWARD W. SAMS & CO., INC.** ES 084  
4300 West 62nd Street, Indianapolis, Indiana 46206

Order from your Electronics Parts Distributor, or mail to Howard W. Sams & Co., Inc.  
Send books checked at right, \$\_\_\_\_\_ enclosed. Please include sales tax where applicable. Canadian prices slightly higher.

Send FREE 1974 Sams Catalog 007146.

Name \_\_\_\_\_

Address \_\_\_\_\_

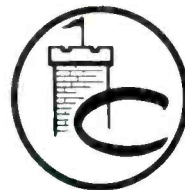
City \_\_\_\_\_ State \_\_\_\_\_ Zip \_\_\_\_\_

- 20975
- 20922
- 20777
- 20912
- 21032
- 20965
- 21004
- 21074
- 21039

For More Details Circle (2) on Reply Card

# SUBBER™

## TV Service Instruments for signal circuit analyzing.



When Castle introduced the TV Tuner SUBBER\* analyzing instrument a couple of years ago it became the first practical way to easily test the VHF tuner, UHF tuner and i.f. amplifier system of any TV receiver. Being lightweight, self contained and battery powered the TV Tuner SUBBER\*Mk. IV is the first such instrument which may be carried on service calls and used with ANY color or black and white TV receiver . . . at \$45.95 for the battery powered Mk. IV, or \$54.95 for the a.c. plus battery powered Mk. IV-A the instruments have been known to pay for themselves in TIMESAVING in the first two weeks of use!

Now we have introduced the Mk. V Master SUBBER\*, an instrument which is absolutely unique . . . there is nothing else like it anywhere! It is completely portable and battery powered, practically foolproof in it's simplicity of operation when testing ALL the signal stages of any color or black and white TV receiver. The substitution signals available allow tests of the following stages: VHF tuner, UHF tuner, each video i.f. amplifier, video detectors, video amplifiers, 4.5 MHz sound i.f. amplifiers, sound limiter, sound detector and audio amplifier. It includes a signal level meter for testing the antenna signal. Inbuilt telescopic antenna makes the meter adaptable for true field strength measurements. Inbuilt monitor loudspeaker ensures foolproof substitution tests . . . every time!

At \$169.95 the Master SUBBER\* instrument is the best bargain in an analyzer that has ever been available. It will save oodles of time in the hands of a professional troubleshooter . . . and help advance the novice to professional status.

All SUBBER\* instruments come complete with batteries, connecting cables and comprehensive instruction manual. The Master SUBBER\* and Mk. IV-A TV Tuner SUBBER\* come complete with wall plug-in transformer for 120vac 60 Hz operation.

As an added bonus, all SUBBER\* instruments enable use of the high speed agc system analyzing procedure invented by Castle . . . the first practical method for analyzing agc system defects without confusion.

\*A trademark of Castle TV Tuner Service, Inc.



These instruments boast the extra features of all Castle products — advanced technology — modern styling — and they work!

If you need to save some analyzing time . . . you need a SUBBER\* instrument!

See your stocking distributor . . . or write for more details and complete specifications.

**CASTLE TV TUNER SERVICE, INC.**

5701 N. Western Ave., Chicago, Illinois 60645 Phone: (312) 561-6354

In Canada: Len Finkler Ltd., Ontario

For More Details Circle (3) on Reply Card